

2.05 T-stuk 90°

Productinformatie

Eigenschappen

- Buitengasdraad
- Rechte buitengasdraad

Materiaal

- PVC-U = Polyvinylchloride zonder weekmaker

Vervaardiging

- Spuitgiet

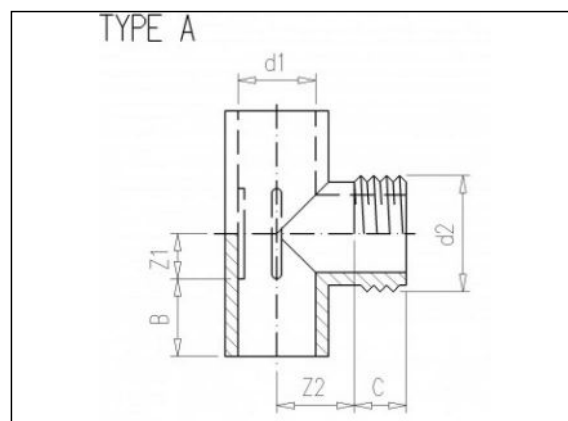

Beschikbare artikelen

ART.CODE	d1	d2	Z1	Z2	B	C	Type	PN	Verp
2.05.015	20	3/4" (M)	11	17	16	16	A	16	250
2.05.020	25	3/4" (M)	14	20	19	16	A	16	300
2.05.025	25	1" (M)	14	20	19	19	A	16	250
2.05.030	32	3/4" (M)	17	23	22	16	A	16	200
2.05.035	32	1" (M)	17	23	22	19	A	16	200
2.05.041	1" (M)	32	31	20	19	22	B	10	250

Van de Lande BV

Lissenveld 1 \ 4941 VK Raamsdonksveer \ The Netherlands \ t +31 (0)162 51 60 00 \ f +31 (0)162 52 14 17 \ sales@vandelande.com
 Traderegister Tilburg: 18070844 \ IBAN: NL13 RABO 0143 0035 26 \ BIC: RABONL2U \ VAT: NL 8123.91.755.B01

ART.CODE	d1	d2	Z1	Z2	B	C	Type	PN	Verp
2.05.046	32	1 1/4" (M)	17	29	22	19	A	10	200
2.05.051	1 1/4" (M)	32	26	17	21	22	B	10	175
2.05.056	1 1/4" (M)	-	26	-	21	-	C	10	175
2.05.060	40	1" (M)	23	27	26	19	A	16	125
2.05.066	40	1 1/4" (M)	23	27	26	21	A	10	140
2.05.067	1 1/4" (M)	40	27	23	21	26	B	10	150
2.05.071	40	1 1/2" (M)	23	27	26	21	A	10	130
2.05.075	50	1" (M)	28	33	31	19	A	16	90
2.05.081	50	1 1/4" (M)	28	33	31	21	A	10	90
2.05.086	50	1 1/2" (M)	28	33	31	21	A	10	90
2.05.090*	63	1" (M)	34	42	38	19	A	16	50
2.05.095*	63	1 1/4" (M)	34	42	38	21	A	16	45
2.05.100*	63	1 1/2" (M)	34	42	38	21	A	16	40
2.05.105*	63	2" (M)	34	42	38	26	A	16	40
2.05.110*	75	1 1/4" (M)	40	50	44	21	A	16	30
2.05.115*	75	1 1/2" (M)	40	50	44	21	A	16	30
2.05.120*	75	2" (M)	40	50	44	26	A	16	28

Van de Lande BV

Lissenveld 1 \ 4941 VK Raamsdonksveer \ The Netherlands \ t +31 (0)162 51 60 00 \ f +31 (0)162 52 14 17 \ sales@vandelande.com
 Traderegister Tilburg: 18070844 \ IBAN: NL13 RABO 0143 0035 26 \ BIC: RABONL2U \ VAT: NL 8123.91.755.B01

www.vandelande.com

All our transactions are subject to the Van de Lande General Terms of Sale. A copy of these can be provided immediately upon your request.