

BE BUMPING
PARTNERS

VDROO

Series

Vertical multistage
stainless steel
centrifugal pump



hydroo®

HYDROO is present in all the European markets by means of a distribution network focused on the service and the valuation of the pumping business. HYDROO conceives, researches, develops, designs, industrializes, and manufactures a wide range of pumping solutions for the most demanding applications in industrial markets, irrigation, water supply and water treatment as well as in residential and commercial buildings. The values of operational excellence, experience, reliability, and passion for a well-done job guide the daily work of the Hydroo team together with our partners and distributors. The global challenges of water management require excellence in pumping technologies and a joint effort between designers, manufacturers, and pumping engineers. To meet the needs of the market in the more demanding installations Hydroo is firmly committed to manufacturing the best pumping equipment on the market following and sharing our values worldwide.

The Hydroo values are presented in 5 great concepts that we summarize in our motto Hy5, which are our principles and commitments:

BE PUMPING PARTNERS



Sant Llorenç de la Muga
(Alt Empordà county, Catalonia)

Sant Llorenç de la Muga is middle age village built in the Muga valley, remaining the rests of the wall, different bridges as well as an impressive architectural ensemble keeping still nowadays the charm of the stone as a raw material for construction.

Coordinates:
Longitude: 2.78890
Latitude: 42.32069



hymotion

Value proposal based on the reliability of products enhancing the quality, the development of efficient supply chains, the productivity with the love of craftsmen at every step of the manufacturing and production lines. We move with the commitment to improve pumping systems, make them more efficient, more reliable, more digitized, more at the service of the human development.



hyllite

Contribution to preservation of the environment and to sustainability. We reduce the environmental impact and footprint of carbon. We contribute to the development of the circular economy. Our team stand out for the highest standards of energy efficiency.



hyficient

The use of the most advanced analytical, development and simulation tools allows us to optimize our R&D teamwork results. We maximize the study of materials, efficient hydraulics, mechanical improvements and the optimization of our motors up to 200 kW. The results are robust, reliable, flexible, adjustable, multipurpose, and user-friendly pumping equipment.



hynovative

Commitment to implementation of the innovation process as strategic pillar of the company. Transfer new ideas to realities that evolve pumping industry and internalize the process in each job position to offer market improvements.



hyliance

We are the factory of our customers. Without solution of continuity between the value chain starting in the components production plants and ending with amortization of the pumping equipment operating at full performance for years and giving satisfaction to distributors, project engineers and pumping systems managers. We make real our catchphrase **Be Pumping Partners**.



INDEX

Description and features	06
Sectional drawings and materials	10
VDR001	12
VDR003	14
VDR005	16
VDR0010	18
VDR0015	20
VDR0020	22
VDR0032	24
VDR0045	26
VDR0065	28
VDR0090	30
VDR00125	32
VDR00150	34
VDR00210	36
Notes	38

VF/VX/ VN/VD

Vertical multistage stainless steel centrifugal pump

Description

Vertical multistage in-line centrifugal pumps made in Stainless Steel. Standard totally enclosed, fan cooled, insulation class F, IP 55 motors. Single phase motors up to 2,2 kW.

WRAS / ACS certified.

VF version: hydraulic part in AISI304 SS, pump inlet/outlet made in cast iron.

VX/VN version: whole pumps available in AISI304 or AISI316L.

VD version: hydraulic part in AISI904 / SS2205.

Performance range

Capacity: Q up to 240 m³/h
Head: H up to 305 m
Temperature: T up to 180 °C
Speed: n 2900 RPM
Power: P up to 110 kW

Standard material

All the parts in contact with liquid made of 304 stainless steel, 316 stainless steel on request. The pump head and suction & discharge can be made of cast iron on request too.



Performance scope

50Hz

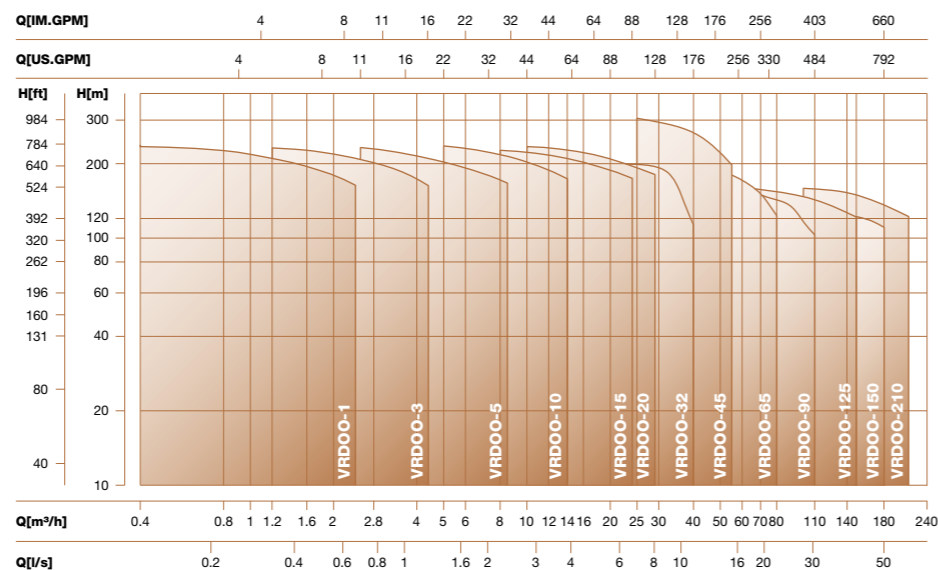

Applications

- Cooling water system
- Municipal water supply and boosting
- Domestic water supply
- Irrigation
- General industrial services
- Washing plants
- Boiler feed and condensate system
- Water treatment

Pump

VDROO is a kind of vertical non-self priming multistage centrifugal pump, which is driven by a standard electric motor. The motor output shaft directly connects with the pump shaft through a coupling. The pressure-resistant cylinder and flow passage components are fixed between pump head and inlet&outlet section with stay bolts. The inlet and outlet are located at the pump bottom at the same plane. This kind of pump can be equipped with an intelligent protector to effectively prevent it from dry-running, out-of-phase and overload.

Motor

Full-enclosed efficiency standard motor air cooled according IEC60034-30-1:2014
 Protection class: IP55
 Insulation class: F
 Standard voltage: 50Hz:
 1x230V
 3x230/400V
 3x400/690V

Application

VDROO is a kind of multifunctional products.

It can be used to convey various medium from tap water to industrial liquid at different temperature and with different flow rate and pressure. VF type is applicable to conveying non-corrosive liquid, while VX, VN is suitable for slightly corrosive liquid.

–**Water supply:** Water filter and transport in waterworks boosting of main pipeline, boosting in high-rise buildings.

–**Industrial boosting:** process flow water system, cleaning system, high-pressure washing system, fire fighting system.

– **Industrial liquid conveying:** Cooling and air-conditioning system, boiler water supply and condensing system, machine-associated purpose, acids and alkali.

–**Water treatment:** Ultra filtration system, reverse osmosis system distillation system, separator, swimming pool.

–**Irrigation :** Farmland irrigation, spray irrigation, dripping irrigation.

Operation conditions

– Thin, clean, non-flammable and non-explosive liquid containing no solid granules and fibers.

– Liquid temperature: -15°C +120°C

– Ambient temperature: up to +40°C

– Altitude: up to 1000m

Product range

Description	VDROO-1	-3	-5	-10	-15	-20	-32	-45	-65	-90	-125	-150	-210
Rated flow [m³/h]	1	3	5	10	15	20	32	45	65	90	125	150	210
Rated flow [l/s]	0.3	0.8	1.4	2.8	4.2	5.6	8,9	11,7	18	24	33	41,6	55,6
Flow range [m³/h]	0.5~2.4	1.2~4.4	2.5~8.5	5~14	8~24	10~29	16-40	25-55	30-80	50-110	60-150	80-180	100-240
Max. pressure. [bar]	24	23	24	24	24	23	29	30	22	17	16	16	16
Motor power [kW]	0.37~2.2	0.37~3	0.37~5.5	0.75~11	1.1~15	1.1~18.5	1,5-30	3-45	4-45	5,5-45	11-75	11-75	18,5-110
Temp. [°C]	-15 ±180						-15 ±120						
Max. efficiency [%]	48	58	70	72	73	73	73	75	76	77	74	73	79
MEI rates	≥ 0,8			≥ 0,7		≥ 0,7	≥ 0,7	≥ 0,7	≥ 0,6	≥ 0,6	≥ 0,6	≥ 0,6	≥ 0,6
VF	•	•	•	•	•	•	•	•	•	•	•	•	•
VX, VN	•	•	•	•	•	•	•	•	•	•	•	•	•
VD							•	•	•	•	•	•	•
VF, VX, VN, VD DIN Flange	DN25	DN25	DN32	DN40	DN50	DN50	DN65	DN80	DN100	DN100	DN125	DN125	DN150
VX, VN Cutting ferrule joint	DN32	DN32	DN32	DN50	DN50	DN50							
VX, VN Pipe thread	R1¼	R1¼	R1¼	R2	R2	R2							
VF, VX, VN Oval Flange	G1	G1	G1¼	G1½									

Definition of model

VF, VX, VN 1, 3, 5, 10, 15, 20
VF, VX, VN, VD 32, 45, 65, 90, 125, 150, 210

Hydraulic part description

V X 10 - 2 - 1 R

Motor description

0'75 T 2340 5 2 IE3

Motor efficiency (According IEC60034)

Number of poles

5: 50 Hz
6: 60 Hz

Rated voltage (x10) (V)

S: Single phase
T: Three phases

Power P2 (kW)

R: Threaded flange connection
O: Oval flange connection
T: Pipe thread connection
V: Cutting ferrule joint connection

Number of reduced impellers
A & B Reduced impeller type. (Omitted if not applicable)

Number of stages

Rated flow (m³/h)

F: Cast iron version
X: SS304 wet parts
N: SS316 wet parts
D: SS904 wet parts

Light vertical multistage centrifugal pump

*For special applications please contact our AED department.

Max. Ambient temperature

When the pump operates under ambient temperature higher than 40°C or at altitudes higher than 1000m, because of low air density and poor cooling effects, the motor output power P2 will be decreased to certain extent. If the pump is operated under the above-said conditions, it should be equipped with motor of higher power.

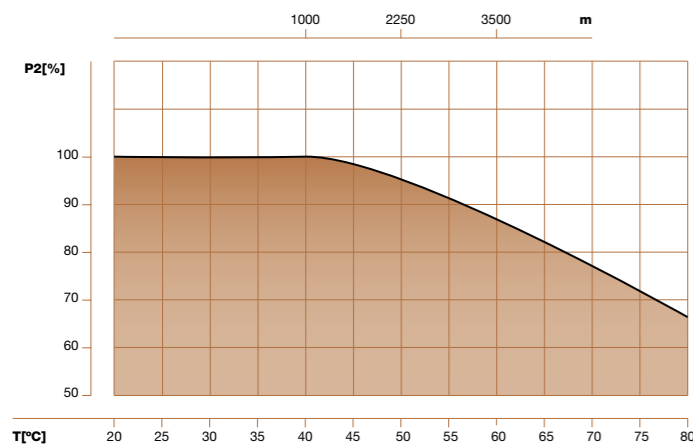

Max. working pressure

Model	Max. pressure (bar)
VF, VX, VN 1,3,5,10,15,20 Flange, cutting ferrule joint, pipe thread	25
VF, VX, VN 1,3,5,10 Oval Flange	16
VF 32-10-1 ~ 32-80	16
VF 32-90-2 ~32-160	30
VX, VN, VD 32	30
VF 45-10-1 ~45-60-2	16
VF 45-60 ~45-90	25
VF 45-100-2 ~45-130-2	30
VX, VN, VD 45-10-1 ~ 45-90	25
VX, VN, VD 45-100-2 ~ 45-130-2	30
VF 65-10-1 ~65-50-2	16
VF 65-50-1 ~65-80-1	25
VF 90-10-1 ~90-40-2	16
VF 90-40 ~90-60	25
VF, VN, VD 65,90	25
VF, VX, VN, VD 125, 150, 210	20

Performance curve

Following conditions are suitable for the performance curves shown below:

- All curves are based on the measured values of 50HZ: constant motor speed 2900rpm or 2950rpm.
- Curve tolerance in conformity with ISO9906 Annex A.
- Measurement is done with 20°C air-free water, kinematic viscosity of 1mm²/sec.
- The operation of pump shall refer to the performance region indicated by the thickened curve to prevent over-heating due to too small flow rate or overload of motor due to too large flow rate.

Curve illustration

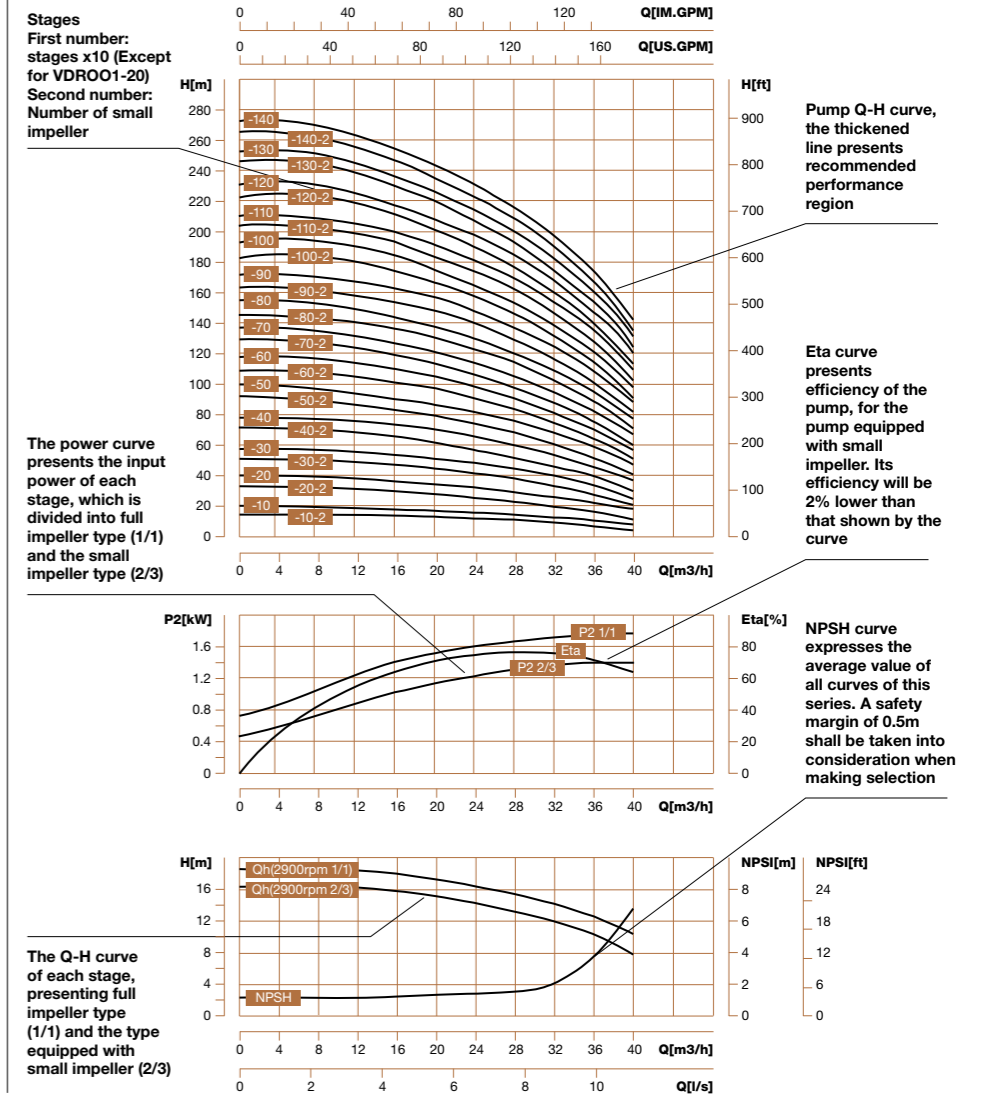

Minimum inlet pressure NPSH

In case that the pressure in pump is lower than the steam pressure used to convey liquid, the cavitations will occur. To avoid cavitations, a minimum pressure at the inlet side of the pump shall be guaranteed.

The maximum suction stroke can be calculated with following formula:
 $H = P_b \times 10.2 - NPSH - H_f - H_v - H_s$
 $P_b = \text{atmosphere pressure [bar]}$ (can be set as 1bar)

In a closed system, P_b means system pressure [bar]

$NPSH = \text{Net positive suction head [m]}$
(It can be read out from the point of possible max. Flow rate shown on NPSH curve)
 $H_f = \text{Pipeline loss at the inlet [m]}$
 $H_v = \text{Steam pressure [m]}$
 $H_s = \text{Safety margin} = \text{Minimum 0.5m delivery head}$

If the calculated result H is positive, the pump may Run under the max. Suction stroke H.

In case the calculated result H is negative, a delivery head of min. Inlet pressure is necessary.

Operation in parallel connecting several pumps in parallel running will benefit much more than running a single large pump.

Applicable to different working states necessary in a variable flow system.

Increasing the possibility of water supply when the pump is in failure, because in case of pump failure, only part of the system flow is effected.

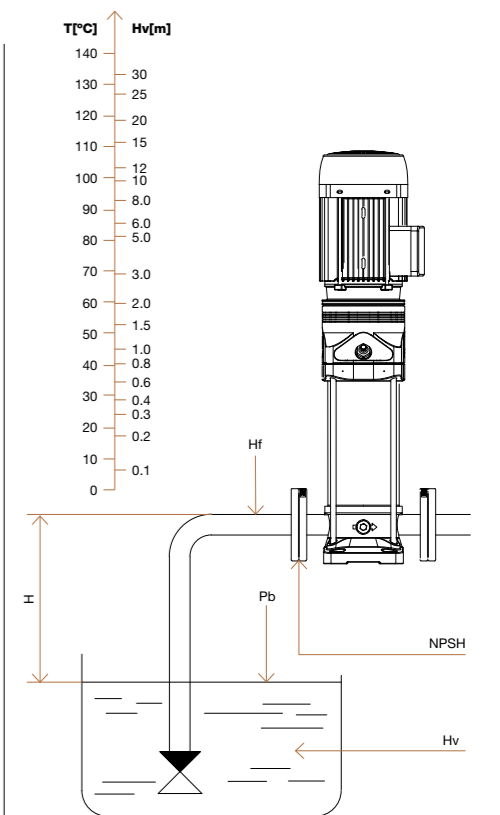
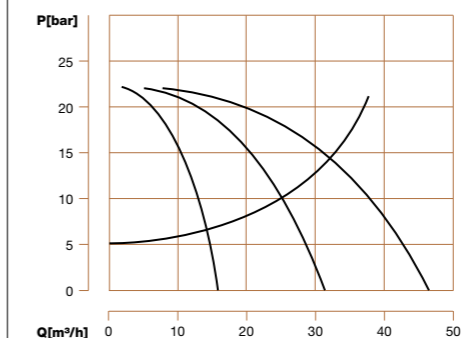

Sectional drawing
VF, VX, VN 1,3,5

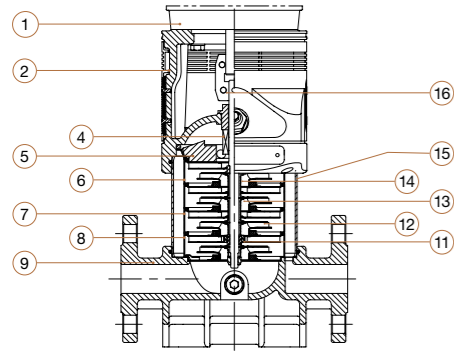

VF

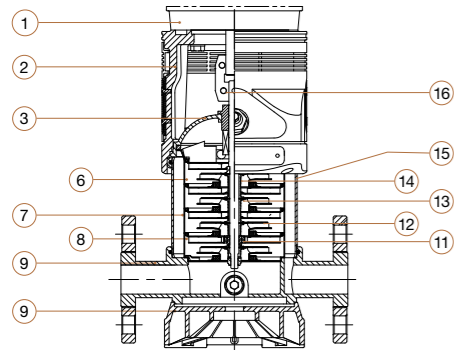

VX, VN

Material
VF, VX, VN 1,3,5

N°	Name	Material	AISI /ASTM
1	Motor		
2	Pump head	Cast iron	ASTM25B
4	Mechanical seal	SiC/SiC/EPDM	
5	Top diffuser	Stainless steel	AISI304 / AISI316L
6	Diffuser	Stainless steel	AISI304 / AISI316L
7	Support diffuser	Stainless steel	AISI304 / AISI316L
8	Inducer	Stainless steel	AISI304 / AISI316L
11	Bearing	Turgsten carbide	
12	Impeller	Stainless steel	AISI304 / AISI316L
13	Shaft	Stainless steel	AISI304 / AISI316L
14	Impeller sleeve	Stainless steel	AISI304 / AISI316L
15	Cylinder	Stainless steel	AISI304 / AISI316L
16	Coupling	Carbon steel	
VX, VN			
3	Seal base	Stainless steel	AISI304 / AISI316L
9	Inlet and outlet chamber	Stainless steel	AISI304 / AISI316L
10	Base plate	Aluminium	ASTM25B
VF			
9	Inlet and outlet chamber	Cast iron	ASTM25B

Sectional drawing
VF, VX, VN, VD 32,45,65,90

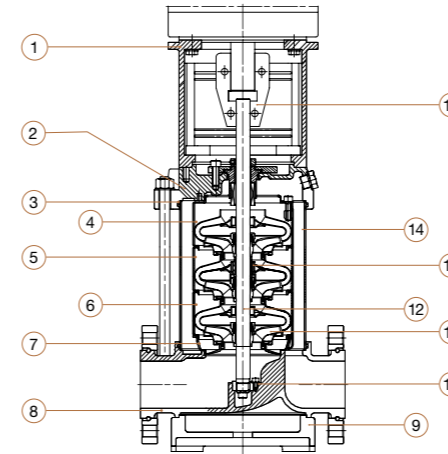

Material
VF, VX, VN, VD 32,45,65,90

N°	Name	Material	AISI /ASTM
1	Bracket	Cast iron	ASTM25B
3	Mechanical seal	SiC/SiC/EPDM	
4	Top diffuser	Stainless steel	AISI304 / AISI316 / SS904L
5	Support diffuser	Stainless steel	AISI304 / AISI316 / SS904L
6	Diffuser	Stainless steel	AISI304 / AISI316 / SS904L
7	Inducer	Stainless steel	AISI304 / AISI316 / SS904L
9	Base plate	Cast iron	ASTM25B
10	Bottom bearing	Carbure de tungstène	
11	Impeller	Stainless steel	AISI304 / AISI316 / SS904L
12	Shaft	Stainless steel	AISI304 / AISI316L / AISI431
13	Intermediate bearing	Turgsten carbide	
14	Cylinder	Stainless steel	AISI304 / AISI316 / SS904L
15	Coupling	Carbon steel	
	Rubber parts	NBR	
VF			
2	Pump head	Cast iron	ASTM25B
8	Inlet and outlet chamber	Cast iron	ASTM25B
VX, VN, VD			
2	Pump head	Stainless steel	AISI304 / AISI316 / SS2205
8	Inlet and outlet chamber	Stainless steel	AISI304 / AISI316 / SS2205

Sectional drawing
VF, VX, VN 10,15,20

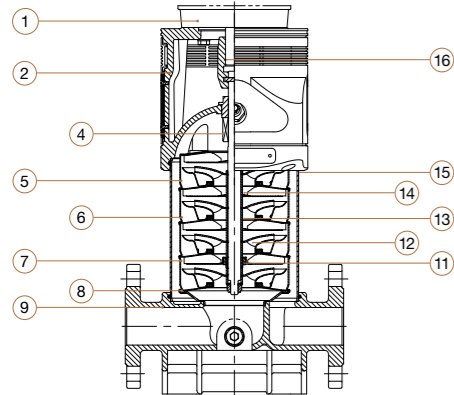

VF

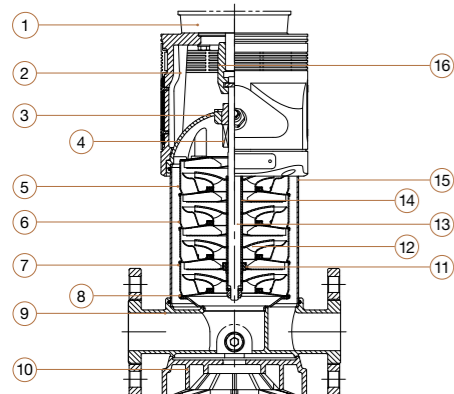

VX, VN

Material
VF, VX, VN 10,15,20

N°	Name	Material	AISI /ASTM
1	Motor		
2	Pump head	Cast iron	ASTM25B
4	Mechanical seal	SiC/SiC/EPDM	
5	Top diffuser	Stainless steel	AISI304 / AISI316L
6	Diffuser	Stainless steel	AISI304 / AISI316L
7	Support diffuser	Stainless steel	AISI304 / AISI316L
8	Inducer	Stainless steel	AISI304 / AISI316L
11	Bearing	Turgsten carbide	
12	Impeller	Stainless steel	AISI304 / AISI316L
13	Shaft	Stainless steel	AISI304 / AISI316L
14	Impeller sleeve	Stainless steel	AISI304 / AISI316L
15	Cylinder	Stainless steel	AISI304 / AISI316L
16	Coupling	Carbon steel	
VX, VN			
3	Seal base	Stainless steel	AISI304 / AISI316L
9	Inlet and outlet chamber	Stainless steel	AISI304 / AISI316L
10	Base plate	Aluminium	ASTM25B
VF			
9	Inlet and outlet chamber	Cast iron	ASTM25B

Sectional drawing
VF, VX, VN, VD 125,150,210

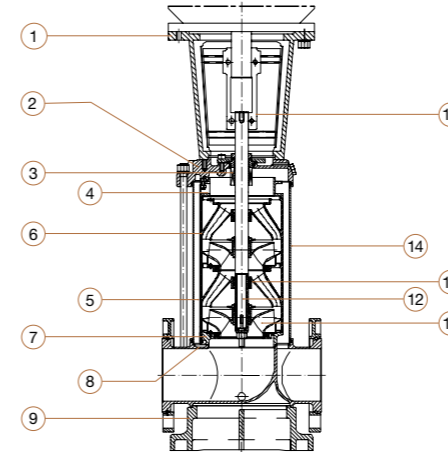

Material
VF, VX, VN, VD 125,150,210

N°	Name	Material	AISI /ASTM
1	Bracket	Cast iron	ASTM25B
3	Mechanical seal	SiC/SiC/EPDM	
4	Discharge	Stainless steel	AISI304 / AISI316 / SS904L
5	Support diffuser	Stainless steel	AISI304 / AISI316 / SS904L
6	Diffuser	Stainless steel	AISI304 / AISI316 / SS904L
7	Inducer	Stainless steel	AISI304 / AISI316 / SS904L
9	Base plate	Cast iron	ASTM 80-55-06
11	Impeller	Stainless steel	AISI304 / AISI316 / SS904L
12	Shaft	Stainless steel	AISI304 / AISI316 / SS904L
13	Bearing	Turgsten carbide	
14	Cylinder	Stainless steel	AISI304 / AISI316 / SS904L
15	Coupling	Carbon steel	
	Rubber parts	NBR	
VF			
2	Pump head	Cast iron	ASTM 80-55-06
8	Inlet and outlet chamber	Stainless steel	ASTM 80-55-06
VX, VN, VD			
2	Pump head	Stainless steel	AISI304 / AISI316 / SS2205
8	Inlet and outlet chamber	Stainless steel	AISI304 / AISI316 / SS2205

VDR001

Installation sketch

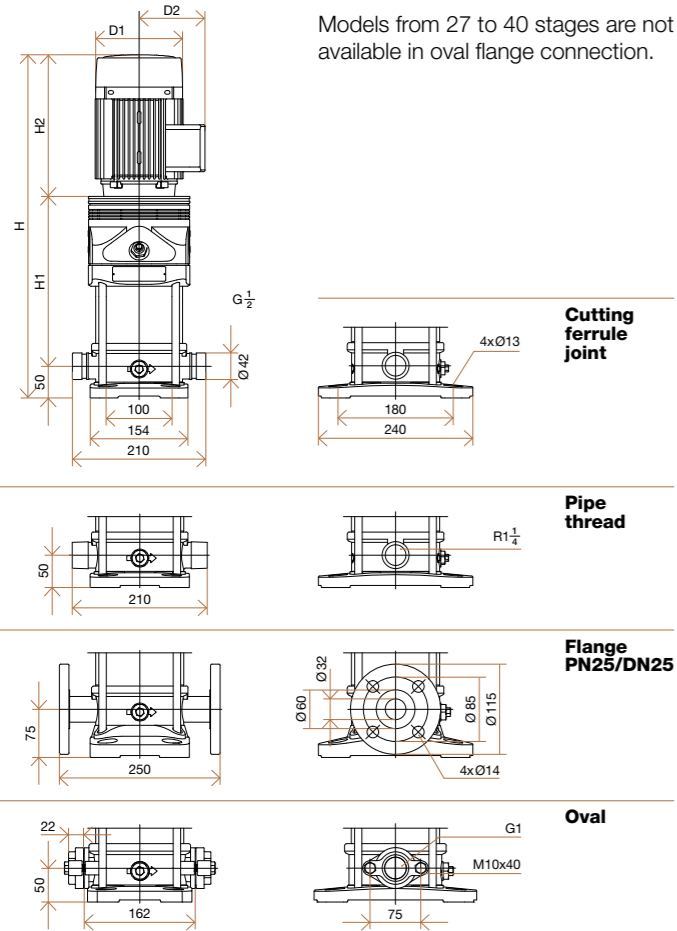

Size and weight

Model	Pump and motor dimensions						Weight (kg)	
	H1	H2	H	D1	D2	VF	VX, VN	
VF, VX, VN-1-3	207	215	497/472	140	103	23	19	
VF, VX, VN-1-4	227	215	517/492	140	103	24	20	
VF, VX, VN-1-5	247	215	537/512	140	103	24	20	
VF, VX, VN-1-6	267	215	557/532	140	103	25	21	
VF, VX, VN-1-7	287	215	577/552	140	103	25	21	
VF, VX, VN-1-8	307	215	597/572	140	103	27	23	
VF, VX, VN-1-9	327	215	617/592	140	103	27	23	
VF, VX, VN-1-10	347	215	637/612	140	103	28	24	
VF, VX, VN-1-11	367	215	687/662	140	103	28	24	
VF, VX, VN-1-12	397	245	717/692	151	108	31	27	
VF, VX, VN-1-13	417	245	737/712	151	108	31	27	
VF, VX, VN-1-15	457	245	777/752	151	108	32	28	
VF, VX, VN-1-17	497	245	817/792	151	108	35	31	
VF, VX, VN-1-19	537	245	857/832	151	108	36	32	
VF, VX, VN-1-22	597	245	917/892	151	108	37	33	
VF, VX, VN-1-25	667	290	1032/1007	171	120	44	40	
VF, VX, VN-1-27	707	290	1072/1047	171	120	45	41	
VF, VX, VN-1-30	767	290	1132/1107	171	120	46	42	
VF, VX, VN-1-32	807	290	1172/1147	171	120	49	45	
VF, VX, VN-1-34	847	290	1212/1187	171	120	50	46	
VF, VX, VN-1-36	887	290	1252/1227	171	120	51	47	
VF, VX, VN-1-38	927	290	1292/1267	171	120	51	47	
VF, VX, VN-1-40	967	290	1332/1307	171	120	52	48	

Performance table

Model	Motor (kW)	Q (m3/h)	0	0.5	0.7	1	1.2	1.4	1.6	1.8	2	2.2	2.4
VF, VX, VN-1-3	0,37	H (m)	17,5	17	16,8	16	15,6	14,8	13,5	12	10	8,5	6
VF, VX, VN-1-4	0,37		23,5	23	22,5	21,5	21	19,8	18	16	13,5	11	8
VF, VX, VN-1-5	0,37		29	28,5	28	27	26	24,5	22,5	20	17	14	10
VF, VX, VN-1-6	0,37		35	34,5	34	32,5	31,5	30	27	24	20,5	17	12,5
VF, VX, VN-1-7	0,37		41	40,5	40	39	37	35	32	28	24	20	15
VF, VX, VN-1-8	0,55		47	46	45,5	43,5	42	40	37	33	29	24,5	18
VF, VX, VN-1-9	0,55		52,5	52	51,5	49	47	44,5	41	37	32	27	20,5
VF, VX, VN-1-10	0,55		58,5	58	57	55	52,5	50	46	42	37	31	23
VF, VX, VN-1-11	0,55		64	63,5	63	61	58,5	55	51	46	40	33,5	25,5
VF, VX, VN-1-12	0,75		70	69	68,5	67	64,5	61	57	52	45,5	37	28
VF, VX, VN-1-13	0,75		75,5	75	74,5	73	70	66,5	61,5	56	49	40,5	31
VF, VX, VN-1-15	0,75		87,5	86,5	85,5	84	81	76,5	71	65	57	47	36
VF, VX, VN-1-17	1,1		99	98	97	95	91,5	86,5	81	73	64	53	41
VF, VX, VN-1-19	1,1		110	109	108	106	103	98	91	82	72	59	46
VF, VX, VN-1-22	1,1	128	127	126	122	118	112	105	95	83	69	54	
VF, VX, VN-1-25	1,5	146	145	144	139	134	128	121	111	98	83	63	
VF, VX, VN-1-27	1,5	158	157	155	150	145	138	130	119	106	90	69	
VF, VX, VN-1-30	1,5	175	174	172	167	161	154	145	133	118	100	77	
VF, VX, VN-1-32	2,2	189	188	186	180	174	166	155	143	129	110	85	
VF, VX, VN-1-34	2,2	200	199	198	192	185	176	165	152	137	117	90	
VF, VX, VN-1-36	2,2	212	211	209	203	196	186	175	161	145	124	95	
VF, VX, VN-1-38	2,2	225	224	221	215	208	197	185	171	153	131	101	
VF, VX, VN-1-40	2,2	237	236	233	226	219	208	195	180	161	138	106	

Performance curve ISO9906:2012 Grade 3B

VDR001 50Hz

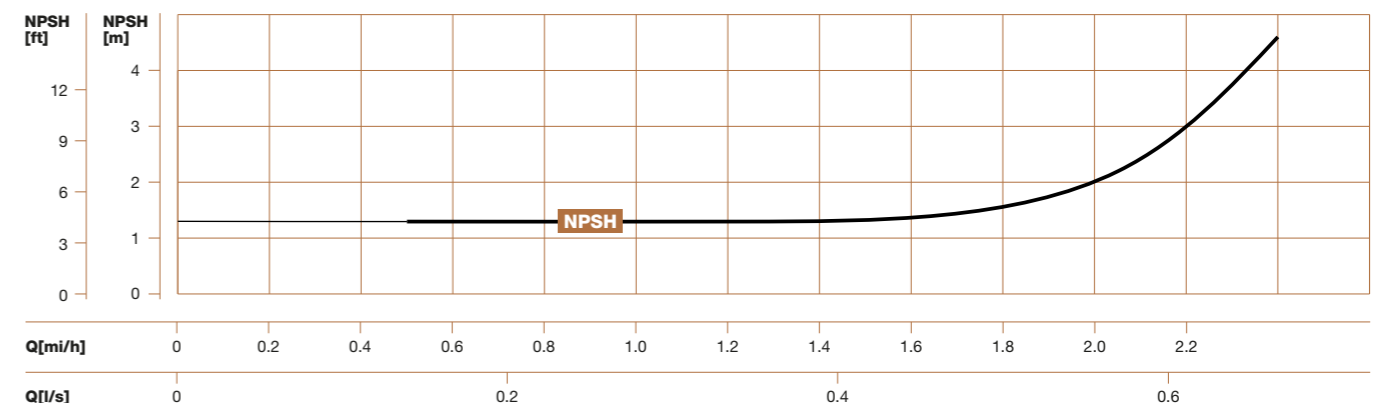
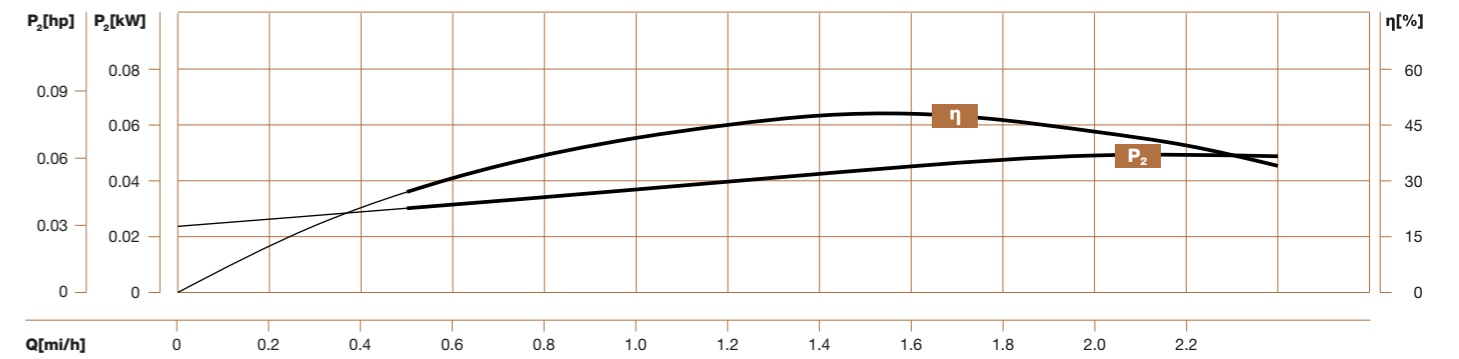
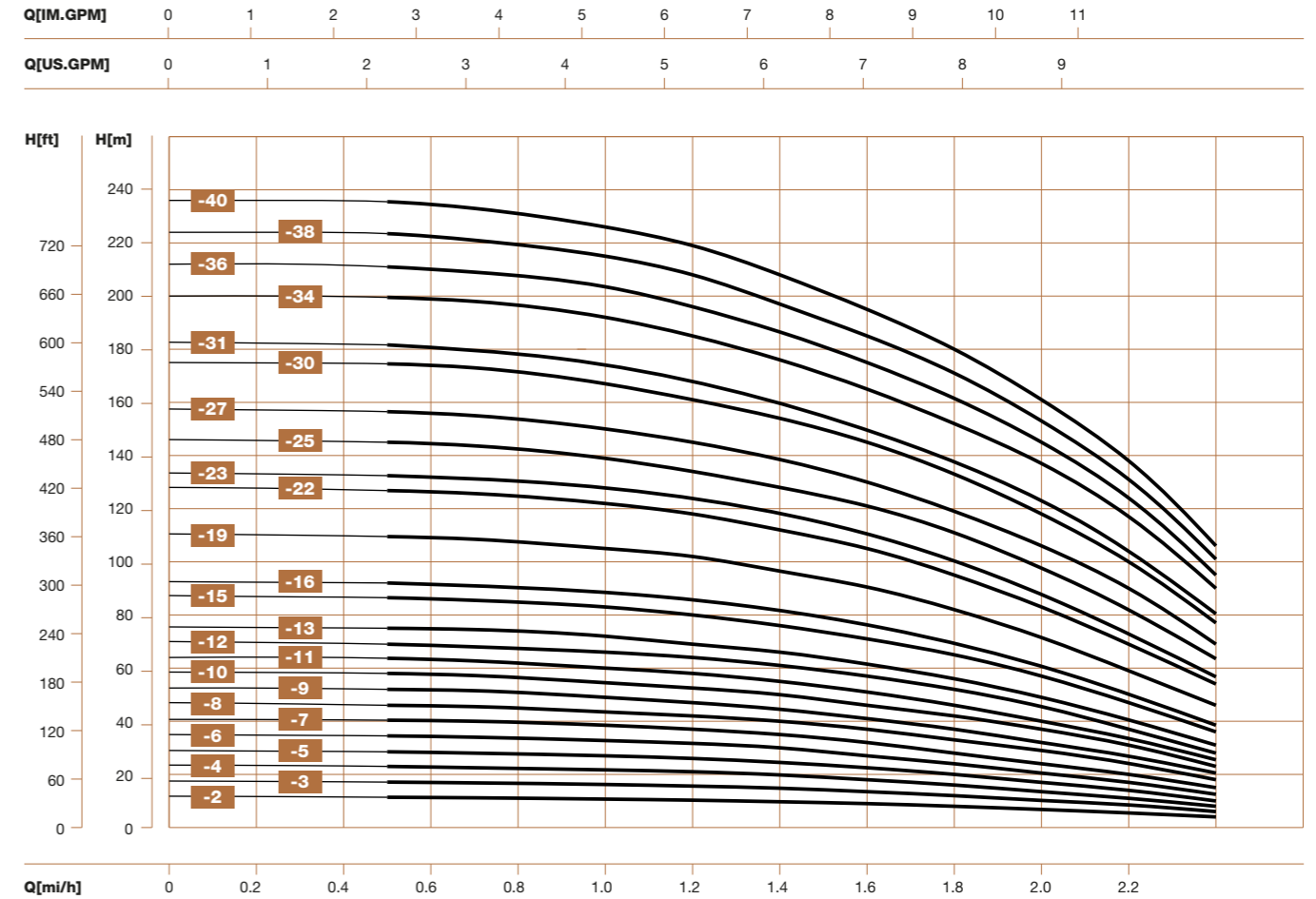

VDR003

Installation sketch

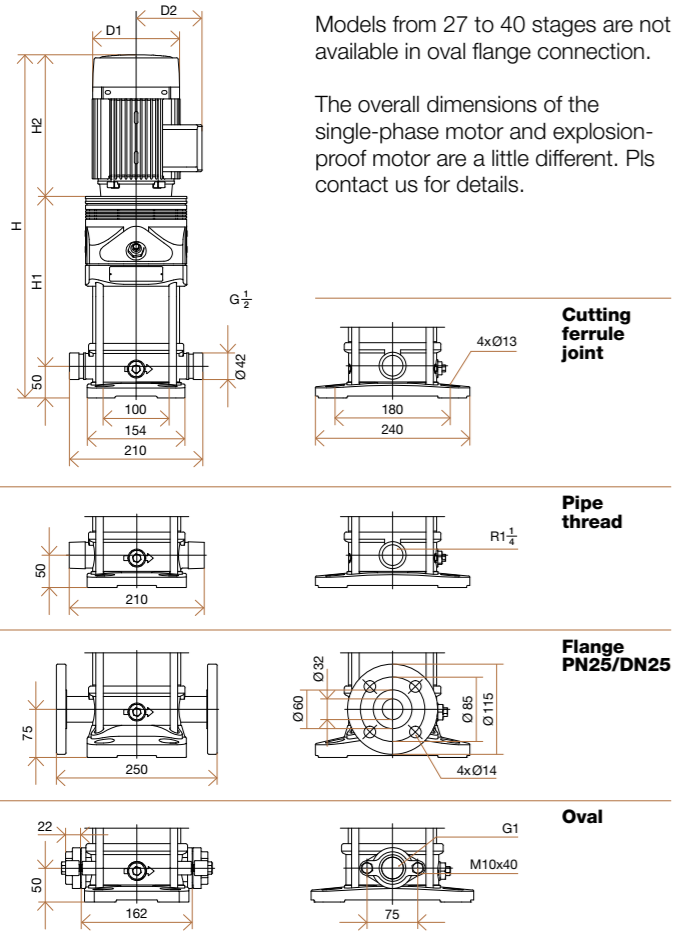

Size and weight

Model	Pump and motor dimensions						Weight (kg)	
	H1	H2	H	D1	D2	VF	VX, VN	
VF, VX, VN-3-3	207	215	497/472	140	103	24	20	
VF, VX, VN-3-4	227	215	517/492	140	103	25	21	
VF, VX, VN-3-5	247	215	537/512	140	103	26	22	
VF, VX, VN-3-6	267	215	557/532	140	103	27	23	
VF, VX, VN-3-7	297	245	617/592	151	108	30	26	
VF, VX, VN-3-8	317	245	637/612	151	108	30	26	
VF, VX, VN-3-9	337	245	657/632	151	108	32	28	
VF, VX, VN-3-10	357	245	677/652	151	108	33	29	
VF, VX, VN-3-11	377	245	697/672	151	108	33	29	
VF, VX, VN-3-12	397	245	717/692	151	108	34	30	
VF, VX, VN-3-13	427	290	792/767	171	120	39	35	
VF, VX, VN-3-14	447	290	812/787	171	120	40	36	
VF, VX, VN-3-15	467	290	832/807	171	120	40	36	
VF, VX, VN-3-16	487	290	852/827	171	120	41	37	
VF, VX, VN-3-19	547	290	912/887	171	120	44	40	
VF, VX, VN-3-21	587	290	952/927	171	120	45	41	
VF, VX, VN-3-23	627	290	992/967	171	120	46	42	
VF, VX, VN-3-25	677	345	1097/1072	196	132	57	53	
VF, VX, VN-3-27	717	345	1137/1112	196	132	58	54	
VF, VX, VN-3-29	757	345	1177/1152	196	132	58	54	
VF, VX, VN-3-31	797	345	1217/1192	196	132	59	55	

Performance curve ISO9906:2012 Grade 3B

VDR003 50Hz

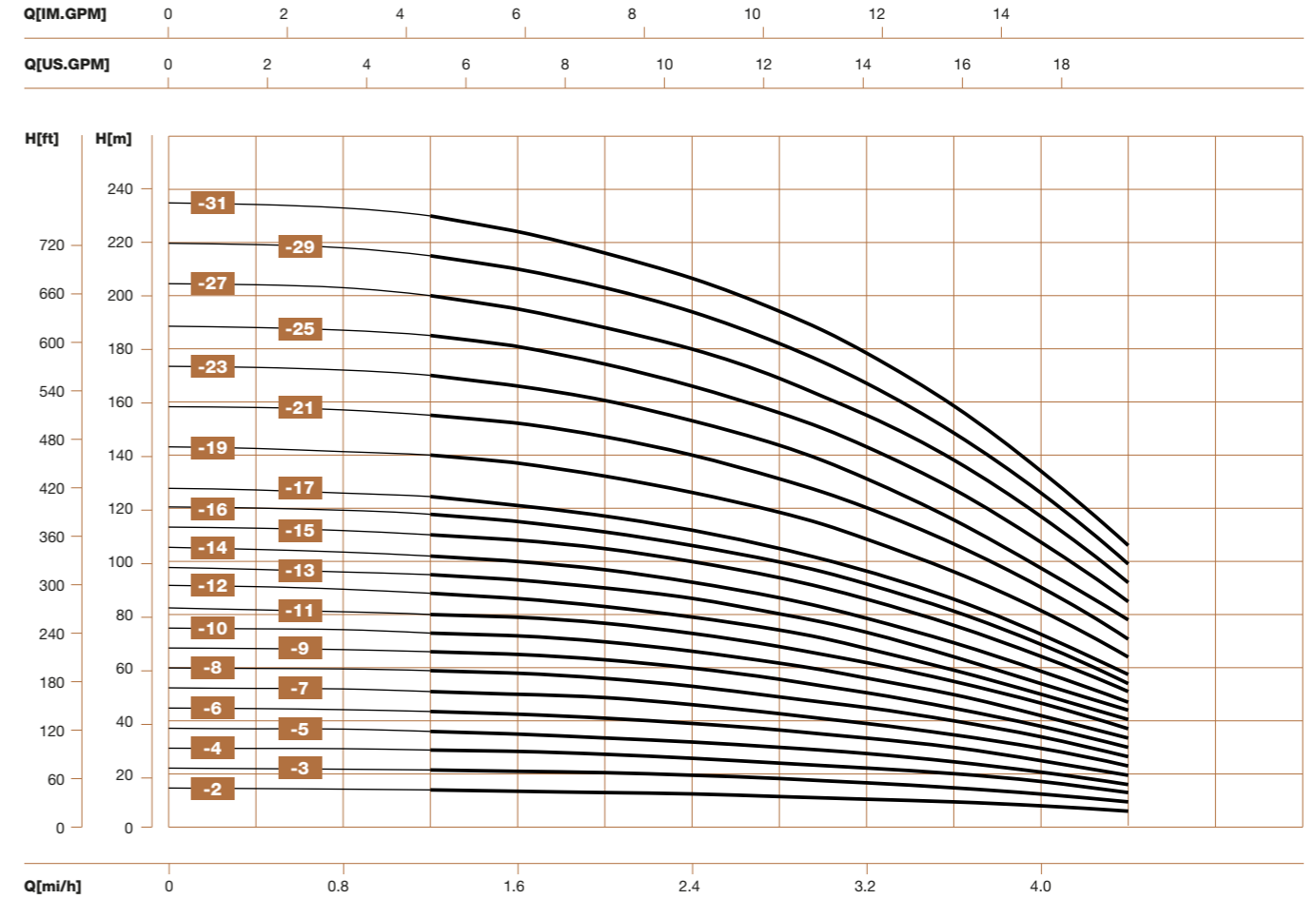

Performance table

Model	Motor (kW)	Q (m³/h)	H (m)												
			0	1,2	1,6	2	2,4	2,8	3	3,2	3,6	4	4,4		
VF, VX, VN-3-3	0.37		22,2	21,5	21	20,5	19,5	18	17	16,5	15	12,5	9,5		
VF, VX, VN-3-4	0.37		29,7	29	28,5	27,5	26	24	23	22	20	17	13		
VF, VX, VN-3-5	0.55		37,2	36	35	33,5	32	30	29	28	25	21	16		
VF, VX, VN-3-6	0.55		45	43,5	42,5	41	39	36,5	35	33,5	30	25	19,5		
VF, VX, VN-3-7	0.75		52,5	51	50	49	46	43	41	39,5	35	30	23		
VF, VX, VN-3-8	0.75		60	58,5	58	56	53	49	47	45	40	34	26,5		
VF, VX, VN-3-9	1.1		67,5	66	65	63	60	56	53	51	45	38	30		
VF, VX, VN-3-10	1.1		75	73	72	70	66	61	59	56	50	42	33,5		
VF, VX, VN-3-11	1.1		82,5	80	79	77	73	68	65	62	55	47	37		
VF, VX, VN-3-12	1.1		90	88	86	83	79	74	71	67	59	50	40,5		
VF, VX, VN-3-13	1.5		98	95	93	90	86	80	77	73	64	54	44		
VF, VX, VN-3-14	1.5		105	102	101	98	92,5	86	83	78	69	58	47		
VF, VX, VN-3-15	1.5		113	110	108	105	100	94	90	86	76	64	51		
VF, VX, VN-3-16	1.5		120	118	116	112	107	100	96	92	81	69	54		
VF, VX, VN-3-19	2.2		143	140	137	132	126	119	114	108	96	82	64		
VF, VX, VN-3-21	2.2		158	155	152	147	140	131	126	120	106	90	71		
VF, VX, VN-3-23	2.2		173	170	166	161	153	144	138	131	115	97	78		
VF, VX, VN-3-25	3		188	185	181	175	166	156	150	142	125	105	85		
VF, VX, VN-3-27	3		204	200	195	188	180	169	162	155	138	117	92		
VF, VX, VN-3-29	3		220	215	210	203	194	182	175	167	148	126	99		
VF, VX, VN-3-31	3		235	230	224	216	207	194	187	178	159	134	106		

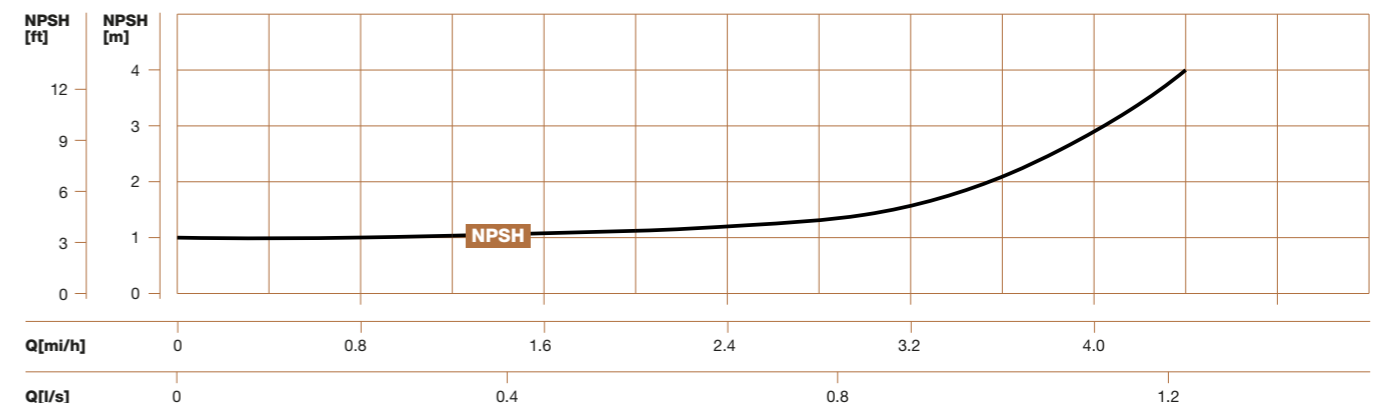
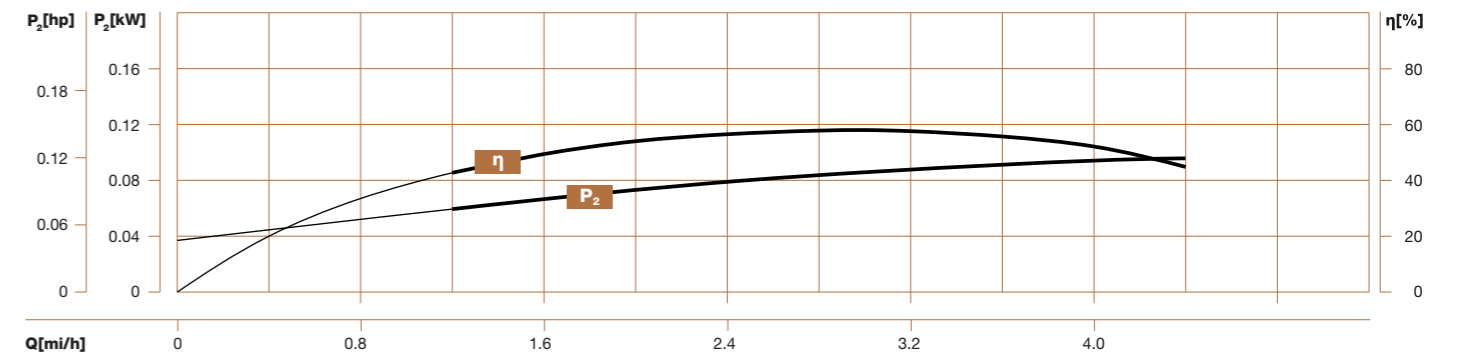

VDR005

Installation sketch

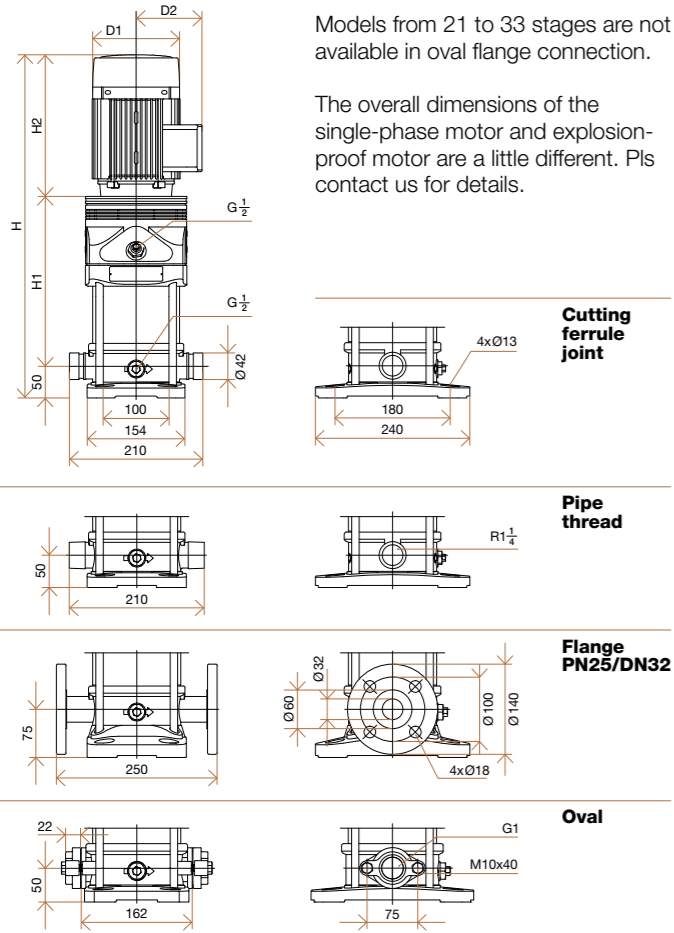

Size and weight

Model	Pump and motor dimensions						Weight (kg)	
	H1	H2	H	D1	D2	VF	VX, VN	
VF, VX, VN-5-3	228	215	518/493	140	103	26	21	
VF, VX, VN-5-4	255	215	545/520	140	103	27	22	
VF, VX, VN-5-5	292	245	612/587	151	108	30	25	
VF, VX, VN-5-6	319	245	639/614	151	108	32	27	
VF, VX, VN-5-7	346	245	666/641	151	108	32	27	
VF, VX, VN-5-8	373	245	693/668	151	108	33	28	
VF, VX, VN-5-9	410	290	775/750	171	120	38	33	
VF, VX, VN-5-10	437	290	802/777	171	120	39	34	
VF, VX, VN-5-11	464	290	829/804	171	120	39	34	
VF, VX, VN-5-12	491	290	856/831	171	120	42	37	
VF, VX, VN-5-13	518	290	883/858	171	120	42	37	
VF, VX, VN-5-14	545	290	910/885	171	120	43	38	
VF, VX, VN-5-15	572	290	937/912	171	120	43	38	
VF, VX, VN-5-16	599	290	964/939	171	120	44	39	
VF, VX, VN-5-18	663	345	1083/1058	196	132	55	50	
VF, VX, VN-5-21	744	345	1164/1139	196	132	57	52	
VF, VX, VN-5-23	798	355	1228/1203	214	151	65	60	
VF, VX, VN-5-25	852	355	1282/1257	214	151	66	61	
VF, VX, VN-5-28	933	355	1363/1338	214	151	67	62	
VF, VX, VN-5-30	1062	390	1527/1502	257	168	88	83	
VF, VX, VN-5-33	1143	390	1608/1583	257	168	89	84	

Performance curve ISO9906:2012 Grade 3B

VDR005 50Hz

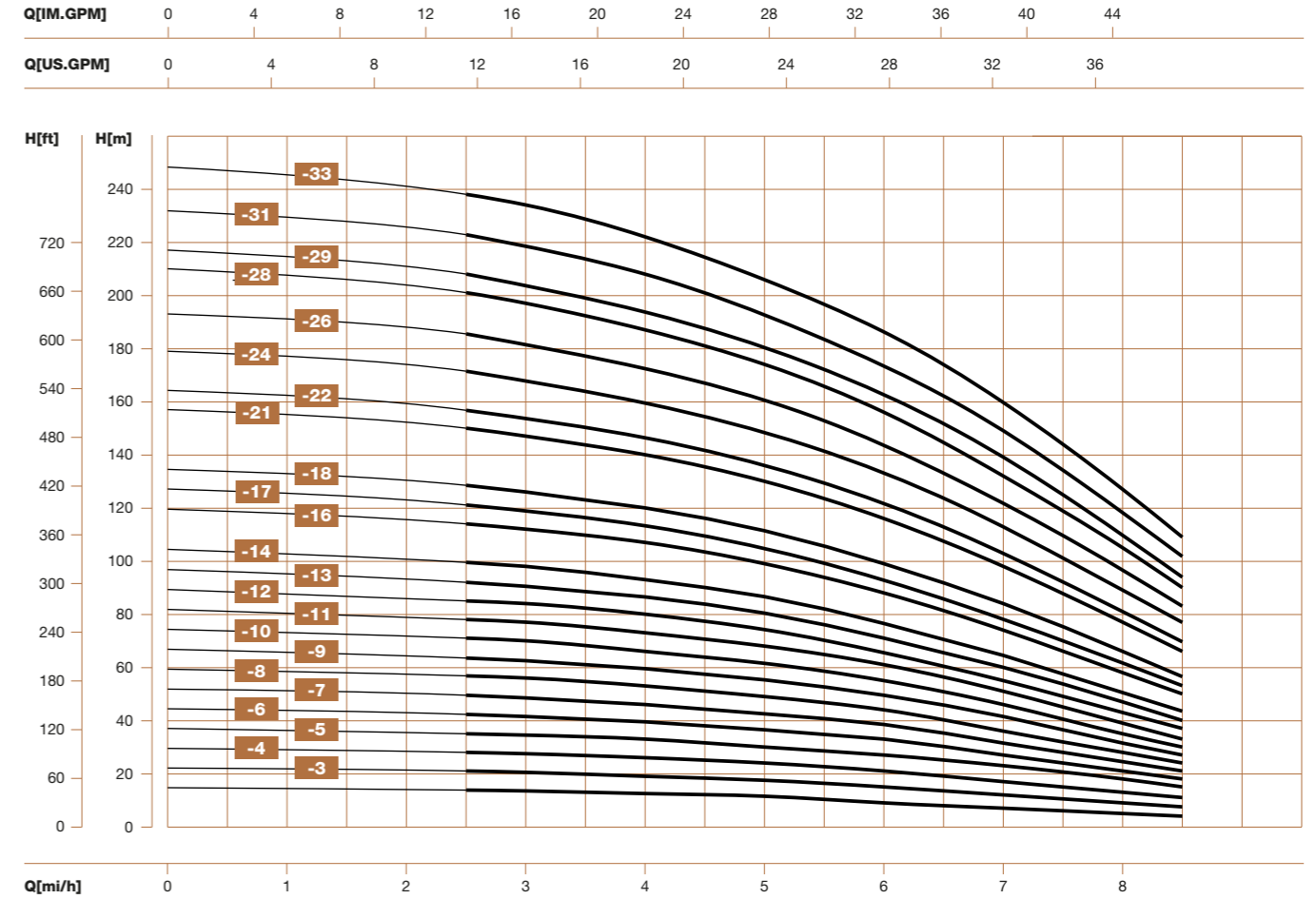

Performance table

Model	Motor (kW)	Q (m³/h)	0	2,5	3	4	5	6	7	8	8,5
VF, VX, VN-5-3	0.55	H (m)	22,1	21	20,5	19	17,5	15	12	9	7,5
VF, VX, VN-5-4	0.55		29,5	28	27,5	26	24	21	17	13	11
VF, VX, VN-5-5	0.75		37	35	34,5	33	30	27	23	18	15
VF, VX, VN-5-6	1.1		44,5	42	41,5	40	37	33	27	21	18
VF, VX, VN-5-7	1.1		52	49,5	48,5	46	42,5	38,5	31,5	24,5	21
VF, VX, VN-5-8	1.1		59	57	56	53	49	44	36	28	24
VF, VX, VN-5-9	1.5		67	64	63	60	55	49,5	41,5	31,5	27
VF, VX, VN-5-10	1.5		74,5	71	70	66	62	55	46	35	30
VF, VX, VN-5-11	1.5		82	78	77	73	68	61	51	39	33
VF, VX, VN-5-12	2.2		89,5	85	84	81	74,5	66	55	43	37
VF, VX, VN-5-13	2.2		97	92	91	87	80	71	60	47	40
VF, VX, VN-5-14	2.2		104	100	98	93	87	77	65	51	43,5
VF, VX, VN-5-15	2.2		112	107	106	100	93	82	69	54	46,5
VF, VX, VN-5-16	2.2		119	114	112	107	99	88	74	58	50
VF, VX, VN-5-18	3		134	128	126	120	111	99	84	66	56
VF, VX, VN-5-21	3		157	150	147	140	130	116	98	77	66
VF, VX, VN-5-23	4		172	165	161	153	142	128	108	86	74
VF, VX, VN-5-25	4		187	179	175	167	155	139	117	93	80
VF, VX, VN-5-28	4		210	201	197	187	174	156	132	105	90
VF, VX, VN-5-30	5.5		225	216	212	201	186	169	144	115	98
VF, VX, VN-5-33	5.5		249	238	234	222	206	187	160	127	109

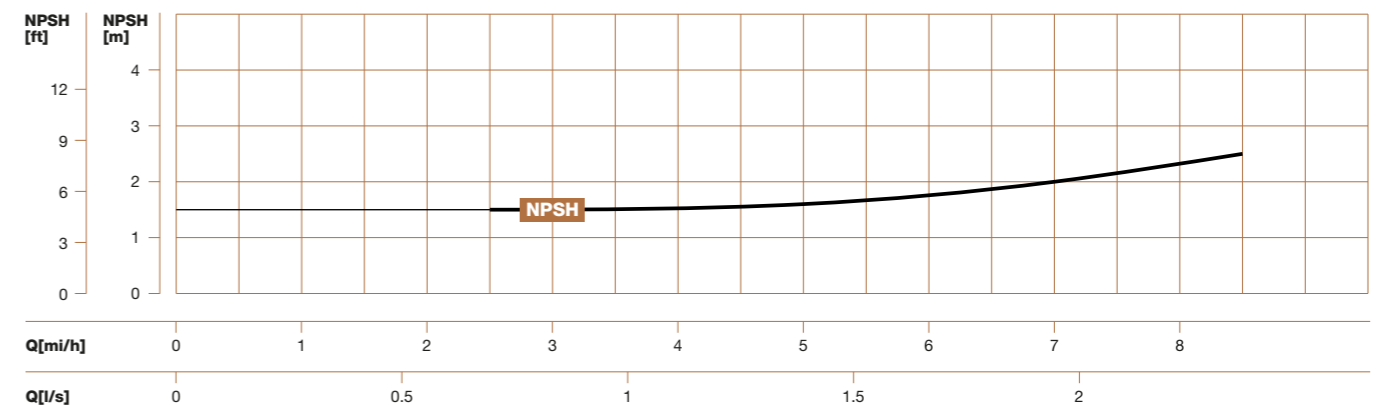
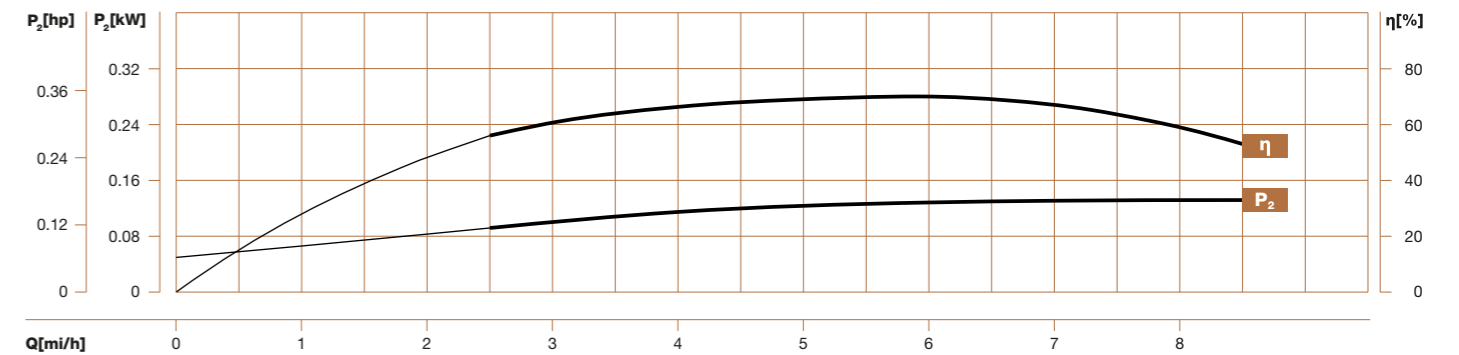

VDR0010

Installation sketch

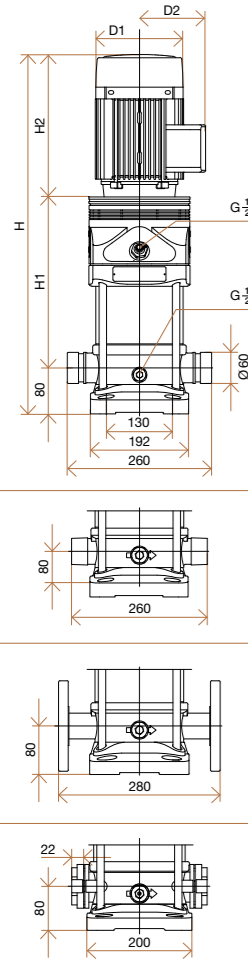

Models from 21 to 33 stages are not available in oval flange connection.

The overall dimensions of the single-phase motor and explosion-proof motor are a little different. Pls contact us for details.

Size and weight

Model	Pump and motor dimensions					Weight (kg)	
	H1	H2	H	D1	D2	VF	VX, VN
VF, VX, VN-10-2	267	245	592	151	108	32	30
VF, VX, VN-10-3	297	245	622	151	108	35	33
VF, VX, VN-10-4	337	290	707	171	120	41	39
VF, VX, VN-10-5	367	290	737	171	120	45	43
VF, VX, VN-10-6	397	290	767	171	120	46	44
VF, VX, VN-10-7	437	345	862	196	132	57	55
VF, VX, VN-10-8	467	345	892	196	132	58	56
VF, VX, VN-10-9	497	355	932	214	151	65	63
VF, VX, VN-10-10	527	355	962	214	151	66	64
VF, VX, VN-10-11	557	355	992	214	151	67	65
VF, VX, VN-10-13	695	390	1165	257	168	88	86
VF, VX, VN-10-15	755	390	1225	257	168	90	88
VF, VX, VN-10-17	815	390	1285	257	168	100	98
VF, VX, VN-10-18	845	390	1315	257	168	101	99
VF, VX, VN-10-20	905	390	1375	257	168	103	101
VF, VX, VN-10-21	935	390	1405	257	168	104	102
VF, VX, VN-10-22	995	500	1575	314	261	170	168

Performance table

Model	Motor (kW)	Q (m³/h)	0	5	6	8	10	12	14
VF, VX, VN-10-2	0.75	H (m)	22,2	21	20,5	19	16,5	13,5	9,5
VF, VX, VN-10-3	1.1		33,3	31,5	31	28,5	25,5	22	16,5
VF, VX, VN-10-4	1.5		44,5	42	41	38	34	29	22
VF, VX, VN-10-5	2.2		56	52,5	51	48	43	37	28
VF, VX, VN-10-6	2.2		67	63	62	58	52	44	34
VF, VX, VN-10-7	3		78,5	74	73	69	62	52	40
VF, VX, VN-10-8	3		90	85	84	79	71	60	46
VF, VX, VN-10-9	4		101,5	96	94	89	80	67	52
VF, VX, VN-10-10	4		113	107	105	98	89	76	58
VF, VX, VN-10-11	4		124	118	115	108	98	84	64
VF, VX, VN-10-13	5.5		147	140	138	130	116	99	76
VF, VX, VN-10-15	5.5		171	162	159	149	134	114	88
VF, VX, VN-10-17	7.5		194	184	180	169	153	130	100
VF, VX, VN-10-18	7.5		205	195	191	180	163	141	108
VF, VX, VN-10-20	7.5		228	217	213	200	181	155	120
VF, VX, VN-10-21	7.5		240	228	223	210	191	162	126
VF, VX, VN-10-22	11		250	240	235	221	201	171	132

Performance curve ISO9906:2012 Grade 3B

VDR0010 50Hz

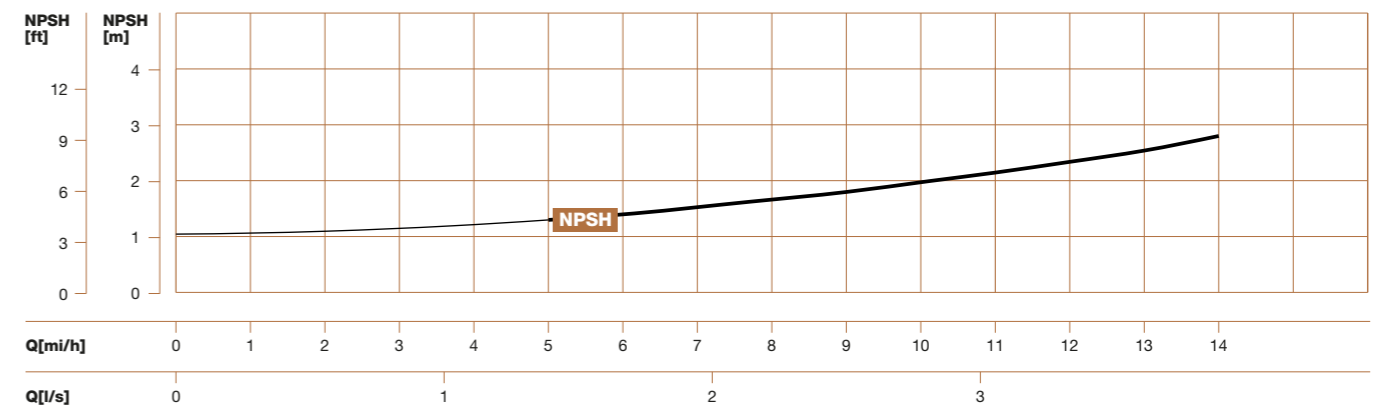
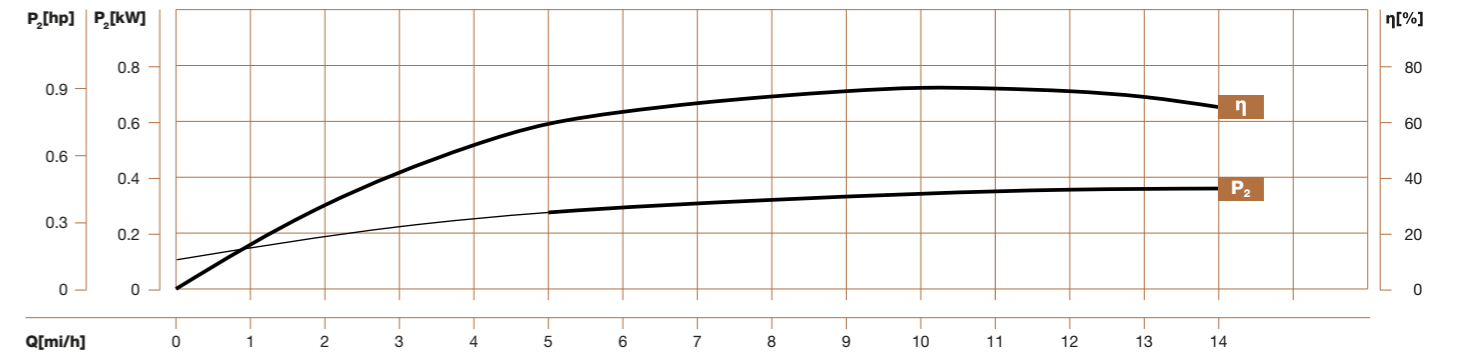
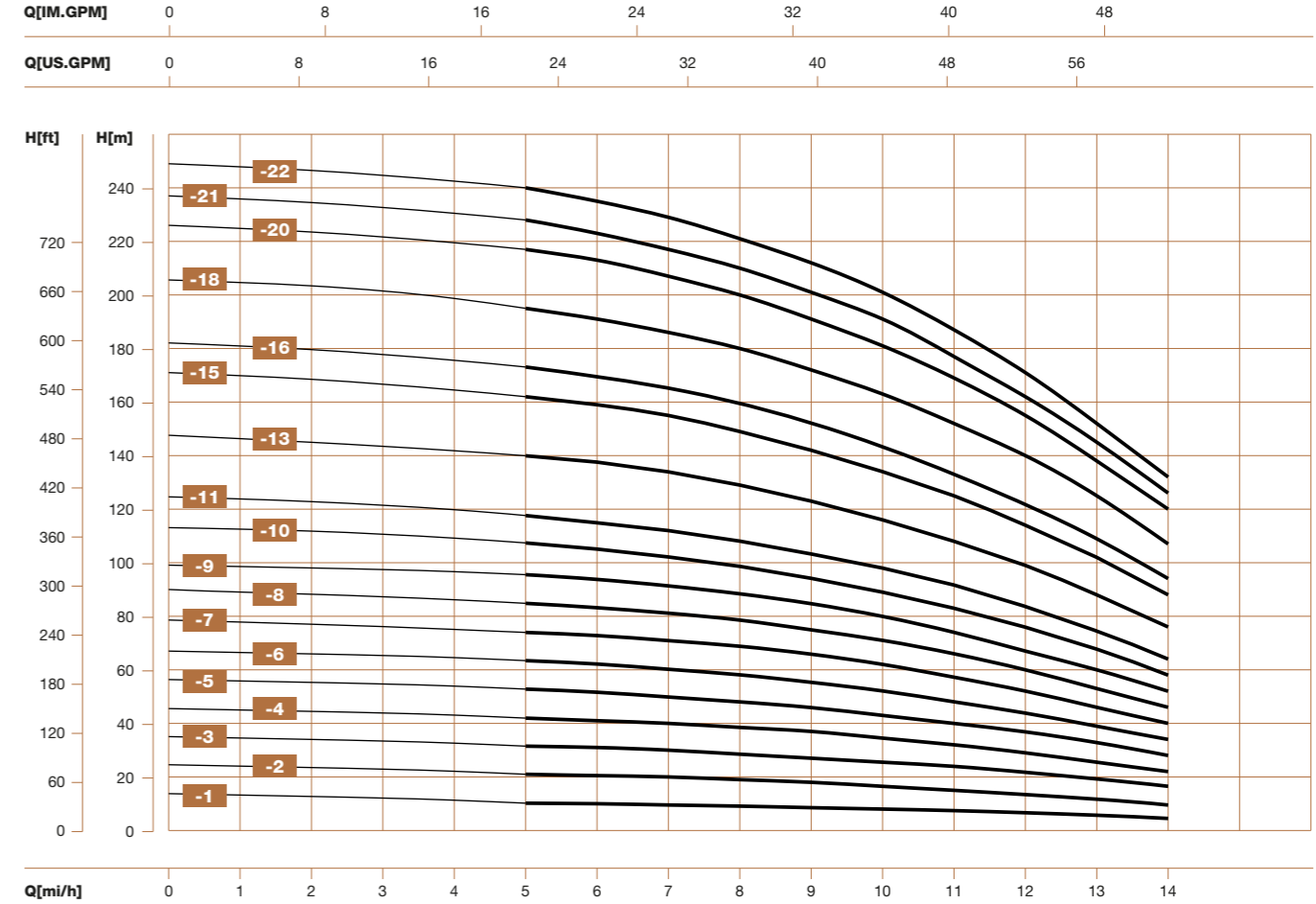

VDR0015

Installation sketch

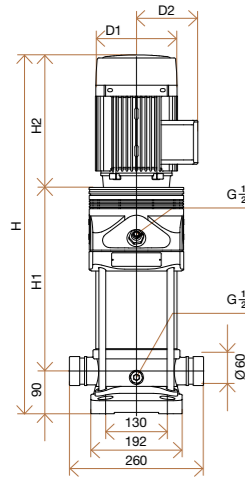

The overall dimensions of the single-phase motor and explosion-proof motor are a little different. Please contact us for details.

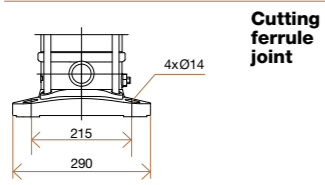

Cutting ferrule joint



Pipe thread

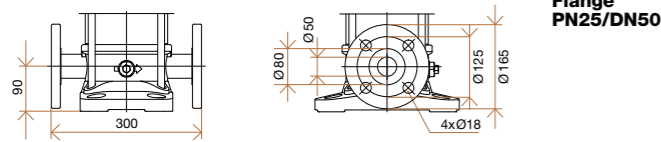

Flange PN25/DN50

Size and weight

Model	Pump and motor dimensions					Weight (kg)	
	H1	H2	H	D1	D2	VF	VX, VN
VF, VX, VN-15-2	307	290	687	171	120	48	41
VF, VX, VN-15-3	362	345	797	196	132	59	52
VF, VX, VN-15-4	407	355	852	214	151	66	59
VF, VX, VN-15-5	452	355	897	214	151	68	61
VF, VX, VN-15-6	575	390	1055	257	168	90	83
VF, VX, VN-15-7	620	390	1100	257	168	91	84
VF, VX, VN-15-8	665	390	1145	257	168	98	91
VF, VX, VN-15-9	710	390	1190	257	168	99	92
VF, VX, VN-15-10	785	500	175	314	261	157	150
VF, VX, VN-15-12	875	500	1465	314	261	160	153
VF, VX, VN-15-14	965	500	1555	314	261	163	156
VF, VX, VN-15-16	1055	500	1645	314	261	182	175
VF, VX, VN-15-18	1145	500	1735	314	261	184	177

Performance table

Model	Motor (kW)	Q (m3/h)	H (m)										
			0	8	10	12	14	15	16	18	20	22	2.4
VF, VX, VN-15-2	2.2		26	24,5	24	23,5	23	22,5	21,5	20	18	16	13,5
VF, VX, VN-15-3	3		40	37,5	37	36,5	35,5	34,5	34	32	29	25	21
VF, VX, VN-15-4	4		54	50,5	50	49	47,5	47	46	43	39	34	28,5
VF, VX, VN-15-5	4		68	63	62	61	59	58	57	53	48	42,5	36
VF, VX, VN-15-6	5.5		82	76	75	73	71	69	67	63	58	52	43
VF, VX, VN-15-7	5.5		96	89	88	86	83	81	79	74	68	61	51
VF, VX, VN-15-8	7.5		110	102	100	98	95	93	91	85	78	69	59
VF, VX, VN-15-9	7.5		124	115	113	111	108	106	103	96	88	78	67
VF, VX, VN-15-10	11		138	128	126	124	121	118	115	107	98	87	75
VF, VX, VN-15-12	11		166	154	152	149	145	142	138	129	117	104	90
VF, VX, VN-15-14	11		194	180	177	173	168	165	160	149	136	122	106
VF, VX, VN-15-16	15		222	209	205	200	194	189	184	172	157	142	125
VF, VX, VN-15-18	15		250	235	231	225	218	213	207	194	177	160	141

Performance curve ISO9906:2012 Grade 3B

VDR0015 50Hz

Q [IM.GPM]	0	8	16	24	32	40	48	56	64	72	80		
Q [US.GPM]	0	8	16	24	32	40	48	56	64	72	80	88	96

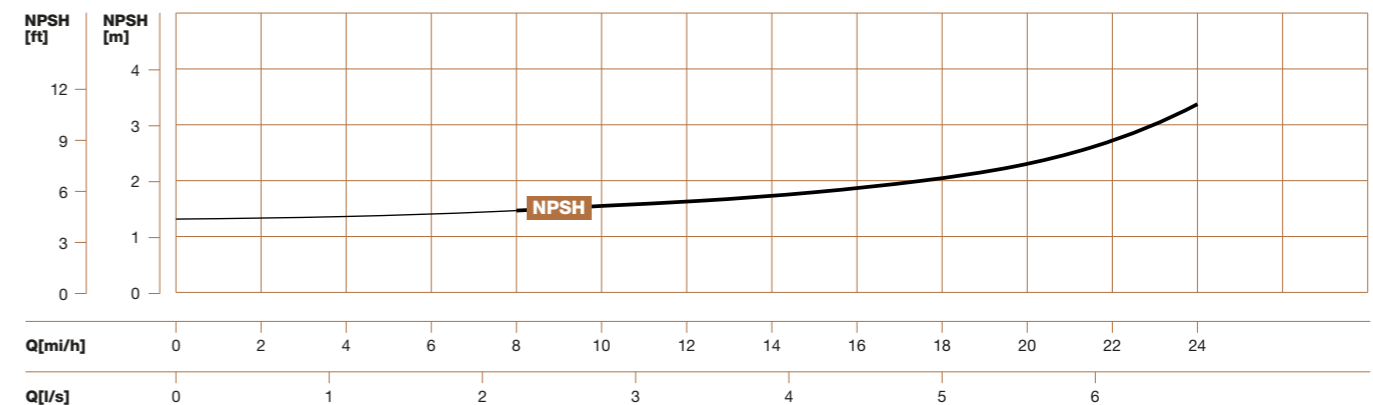
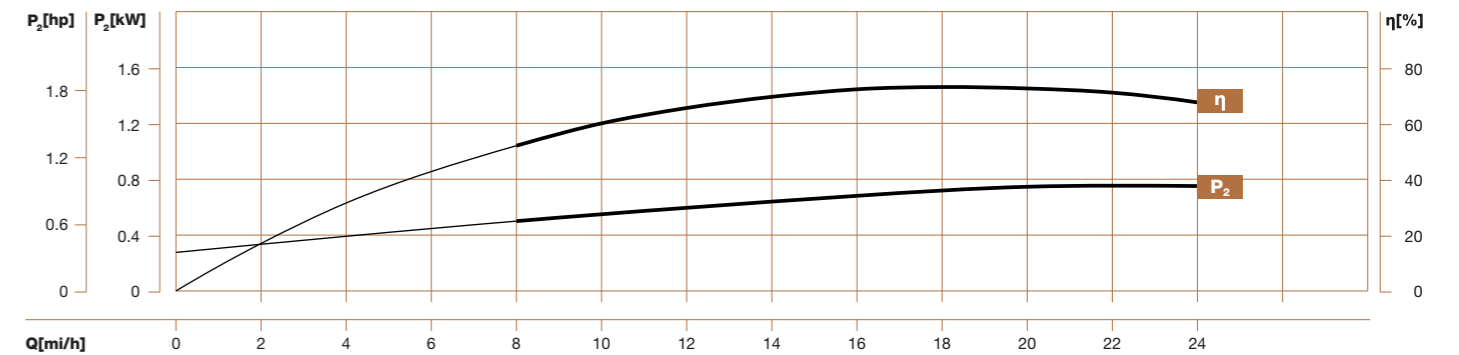
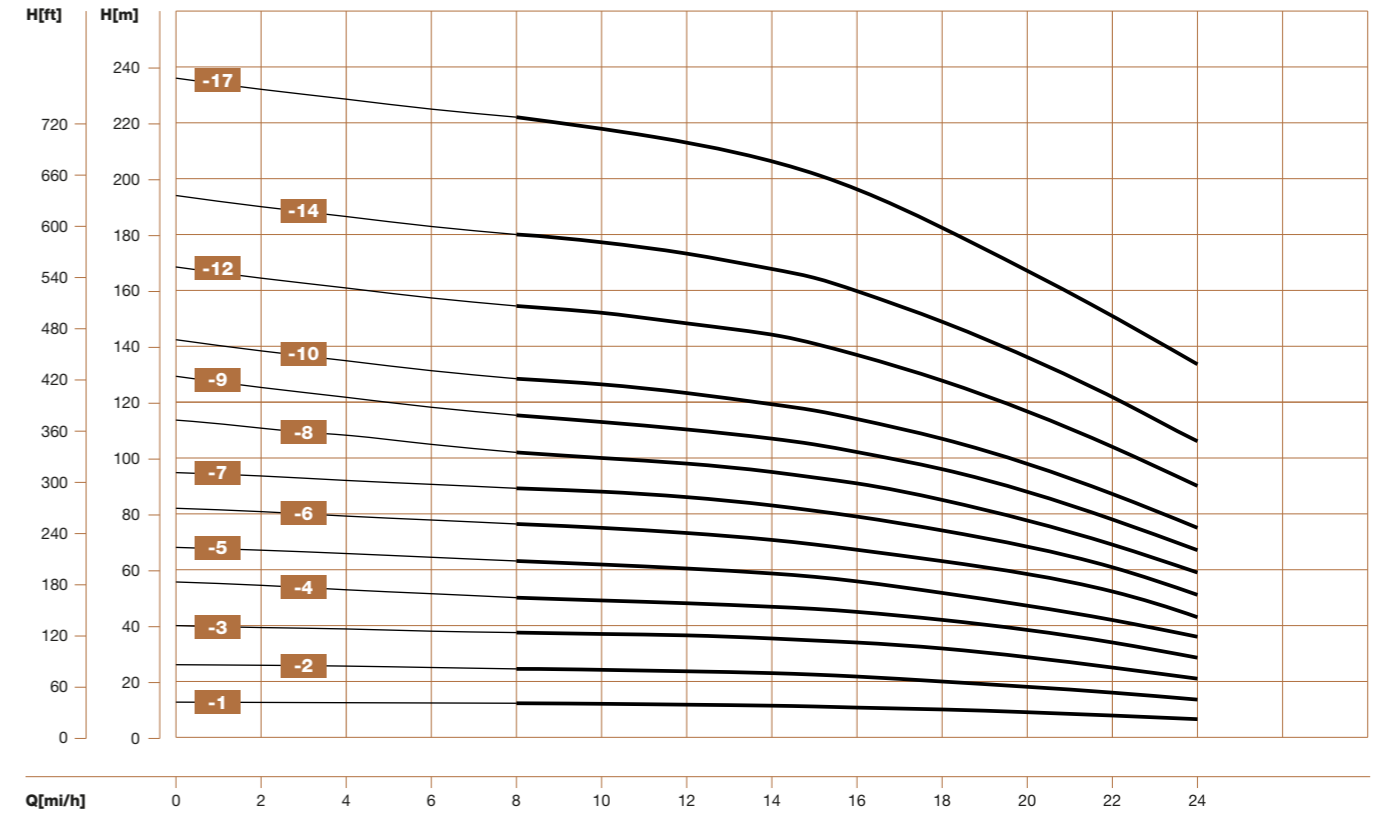

VDROO20

Installation sketch

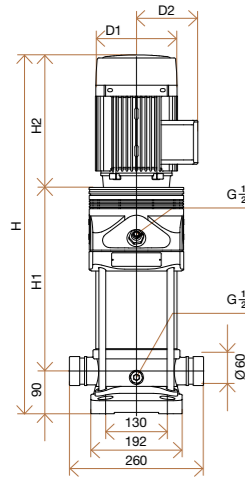

The overall dimensions of the single-phase motor and explosion-proof motor are a little different. Please contact us for details.

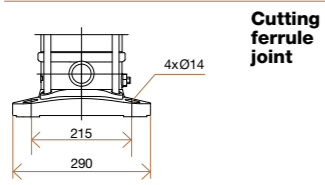

Cutting ferrule joint

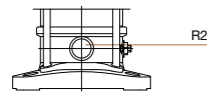
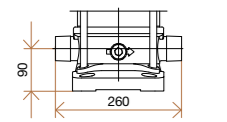

Pipe thread

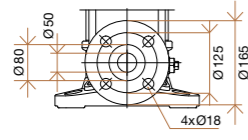
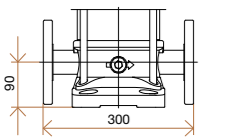

Flange PN25/DN50

Size and weight

Model	Pump and motor dimensions					Weight (kg)	
	H1	H2	H	D1	D2	VF	VX, VN
VF, VX, VN-20-2	307	290	687	171	120	48	41
VF, VX, VN-20-3	362	355	807	214	151	66	59
VF, VX, VN-20-4	485	390	965	257	168	88	81
VF, VX, VN-20-5	530	390	1010	257	168	90	83
VF, VX, VN-20-6	575	390	1055	257	168	99	92
VF, VX, VN-20-7	620	390	1100	257	168	100	93
VF, VX, VN-20-8	695	500	1285	314	261	167	160
VF, VX, VN-20-10	785	500	1375	314	261	170	163
VF, VX, VN-20-12	875	500	1465	314	261	188	181
VF, VX, VN-20-14	965	500	1555	314	261	191	184
VF, VX, VN-20-17	1100	550	1740	314	261	212	205

Performance curve ISO9906:2012 Grade 3B

VDROO20 50Hz

Q [IM.GPM]	0	8	16	24	32	40	48	56	64	72	80	88	96			
Q [US.GPM]	0	8	16	24	32	40	48	56	64	72	80	88	96	104	112	120

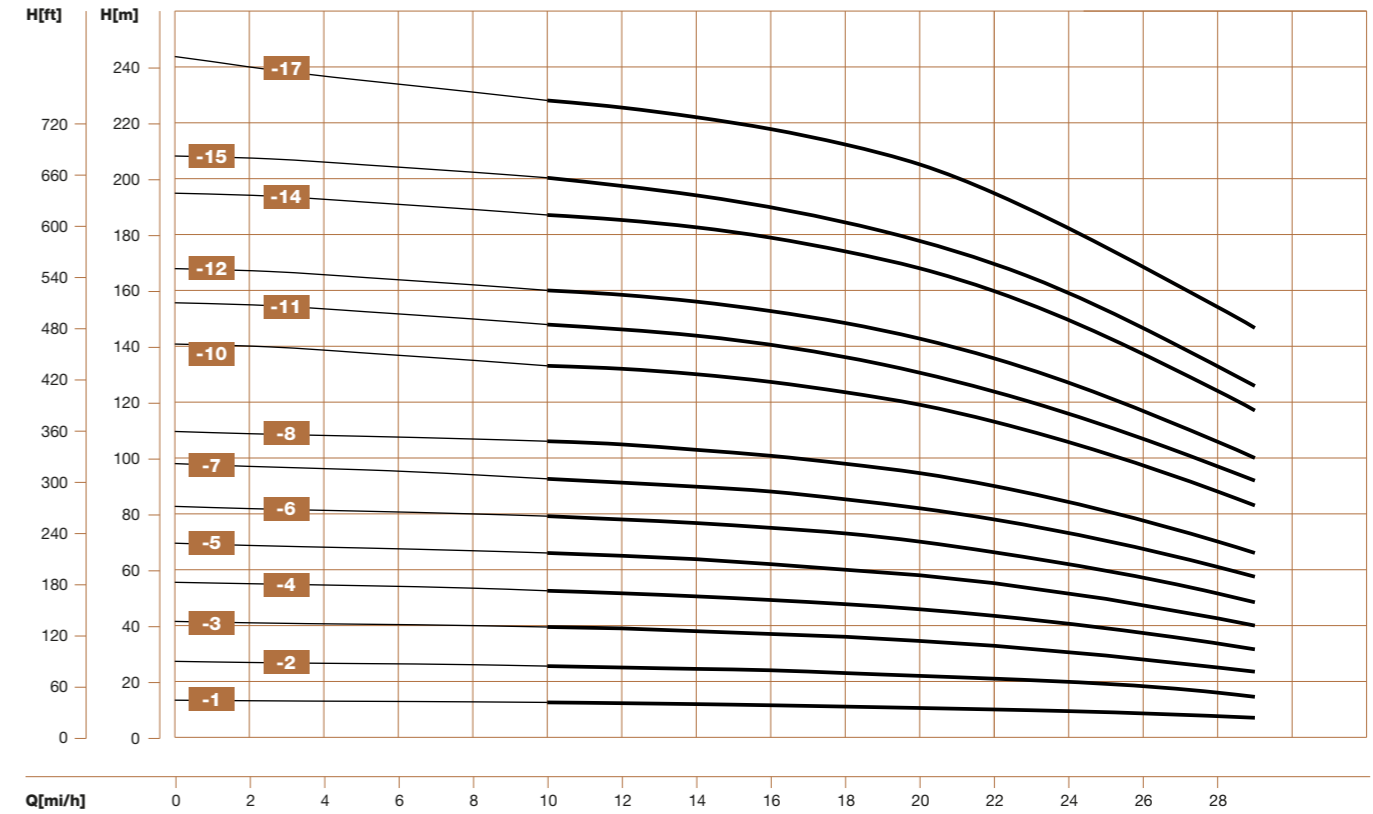

Performance table

Model	Motor (kW)	Q (m3/h)	0	10	12	14	16	18	20	22	24	26	28	29
VF, VX, VN-20-2	2.2	H (m)	27,2	25,5	25	24,5	24	23,7	23	22	20,5	18	16	14,5
VF, VX, VN-20-3	4		41,5	39,5	39	38	37	36	35	33	31	28	25	23,5
VF, VX, VN-20-4	5.5		55,5	52,5	51	50	49	48,5	47	45	41,5	37	33	31,5
VF, VX, VN-20-5	5.5		69,5	66	65	64	62	60	58	55	51	47	42	40
VF, VX, VN-20-6	7.5		84	79	78	77	75	73	70	66	62	58	52	48
VF, VX, VN-20-7	7.5		98	92,5	91	90	88	85	82	78	73	68	61	57,5
VF, VX, VN-20-8	11		113	106	105	103	101	98	95	90	84	77	70	66
VF, VX, VN-20-10	11		141	133	132	130	127	123	119	113	106	97	88	83
VF, VX, VN-20-12	15		171	160	158	156	153	149	143	137	127	117	106	100
VF, VX, VN-20-14	15		200	187	185	183	179	174	168	160	149	137	124	117
VF, VX, VN-20-17	18.5		244	228	225	222	218	212	205	195	182	168	154	147

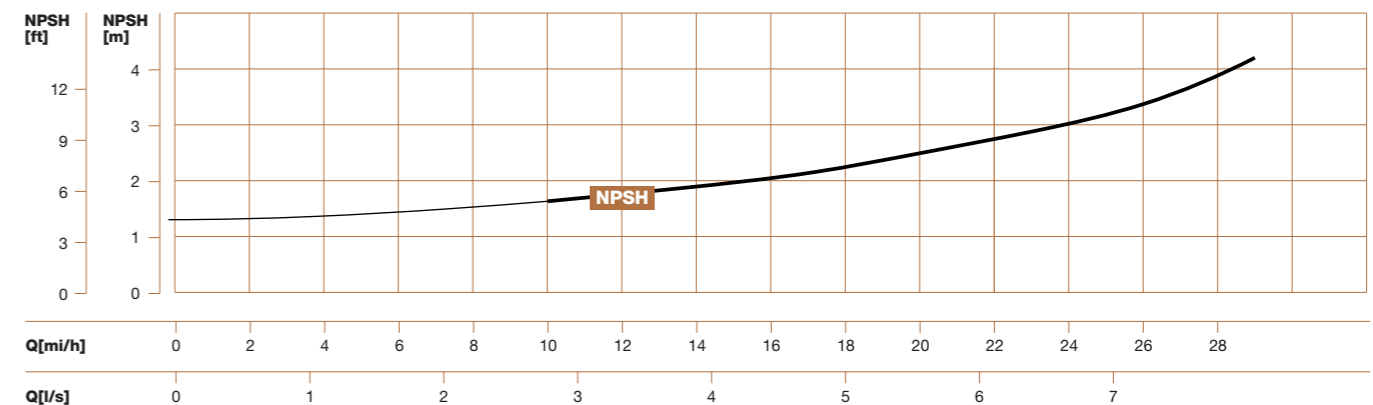
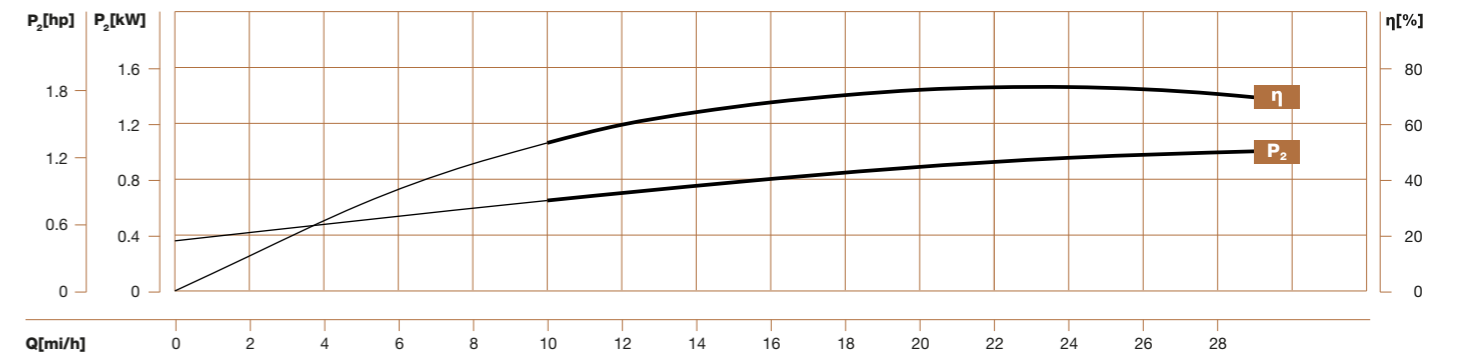

VDR0032

Installation sketch

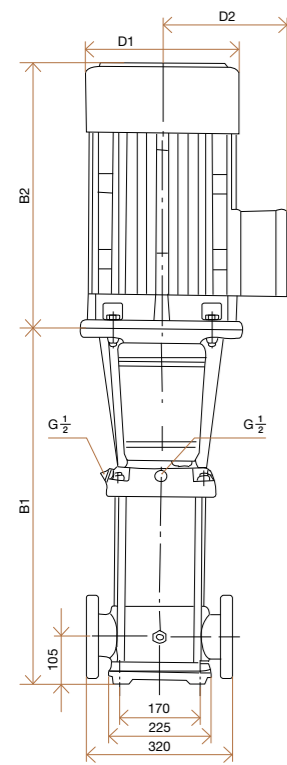

The overall dimensions of the single-phase motor and explosion-proof motor are a little different. Please contact us for details.

PN25-40/DN65

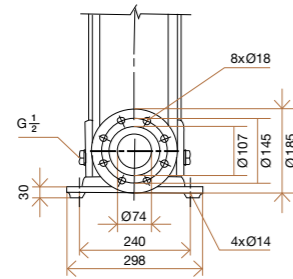

Size and weight

Model	Pump and motor dimensions					Weight (kg)
	B1	B2	B	D1	D2	
VF, VX, VN, VD-32-10	505	290	795	190	155	68
VF, VX, VN, VD-32-20-2/32-20	575	345/355	920/930	197/230	165/180	77/85
VF, VX, VN, VD-32-30-2/32-30	645	390	1035	260	208	100
VF, VX, VN, VD-32-40-2/32-40	715	390	1105	260	208	109
VF, VX, VN, VD-32-50-2/32-50	890	500	1390	330	255	181
VF, VX, VN, VD-32-60-2/32-60	960	500	1460	330	255	185
VF, VX, VN, VD-32-70-2/32-70	1030	500	1530	330	255	199
VF, VX, VN, VD-32-80-2/32-80	1100	500	1600	330	255	203
VF, VX, VN, VD-32-90-2/32-90	1170	550	1720	330	255	222
VF, VX, VN, VD-32-100-2/32-100	1240	550	1790	330	255	227
VF, VX, VN, VD-32-110-2/32-110	1310	575	1885	360	285	272
VF, VX, VN, VD-32-120-2/32-120	1380	575	1955	360	285	276
VF, VX, VN, VD-32-130-2/32-130	1450	650	2100	400	310	337
VF, VX, VN, VD-32-140-2/32-140	1520	650	2170	400	310	341
VF, VX, VN, VD-32-150-2/32-150	1590	650	2240	400	310	345
VF, VX, VN, VD-32-160-2/32-160	1660	650	2310	400	310	350

Performance table

Model	Driving motor		Q (m³/h)	16	20	24	28	32	36	40
	(kW)	(hp)								
VF, VX, VN, VD-32-10	2,2	3		18	17	15	14	13	11	8
VF, VX, VN, VD-32-20-2	3	4		29	28	26	23	20	16	11
VVF, VX, VN, VD-32-20	4	5,5		36	34	32	29	27	23	18
VF, VX, VN, VD-32-30-2	5,5	7,5		47	44	41	39	33	28	21
VF, VX, VN, VD-32-30	5,5	7,5		54	51	48	44	40	35	27
VF, VX, VN, VD-32-40-2	7,5	10		65	62	58	53	46	40	30
VF, VX, VN, VD-32-40	7,5	10		72	69	65	59	53	47	37
VF, VX, VN, VD-32-50-2	11	15		83	79	74	68	60	52	41
VF, VX, VN, VD-32-50	11	15		90	86	81	74	67	59	47
VF, VX, VN, VD-32-60-2	11	15		101	97	90	83	74	65	51
VF, VX, VN, VD-32-60	11	15		108	104	97	90	81	72	57
VF, VX, VN, VDN-32-70-2	15	20		119	114	107	98	88	78	60
VF, VX, VN, VD-32-70	15	20		126	121	113	105	95	85	67
VF, VX, VN, VD-32-80-2	15	20		136	131	123	114	102	90	71
VF, VX, VN, VD-32-80	15	20		144	138	130	120	109	97	77
VF, VX, VN, VD-32-90-2	18,5	25	H (m)	154	148	140	129	117	102	82
VF, VX, VN, VD-32-90	18,5	25		162	156	147	136	124	109	88
VF, VX, VN, VD-32-100-2	18,5	25		175	166	157	146	131	115	91
VF, VX, VN, VD-32-100	18,5	25		182	173	164	152	138	122	98
VF, VX, VN, VD-32-110-2	22	30		193	184	173	164	146	128	102
VF, VX, VN, VD-32-110	22	30		200	191	180	168	153	135	109
VF, VX, VN, VD-32-120-2	22	30		211	201	189	178	160	140	113
VF, VX, VN, VD-32-120	22	30		218	208	196	184	167	147	120
VF, VX, VN, VD-32-130-2	30	40		230	225	206	193	174	153	124
VF, VX, VN, VD-32-130	30	40		237	225	213	200	181	160	131
VF, VX, VN, VD-32-140-2	30	40		247	235	222	210	189	165	135
VF, VX, VN, VD-32-140	30	40		255	242	229	216	196	172	142
VF, VX, VN, VD-32-150-2	30	40		266	253	239	224	203	178	145
VF, VX, VN, VD-32-150	30	40		274	260	246	231	210	185	152
VF, VX, VN, VD-32-160-2	30	40		284	270	255	240	218	190	156
VF, VX, VN, VD-32-160	30	40		292	277	262	246	225	197	163

Performance curve ISO9906:2012 Grade 3B

VDR0032 50Hz

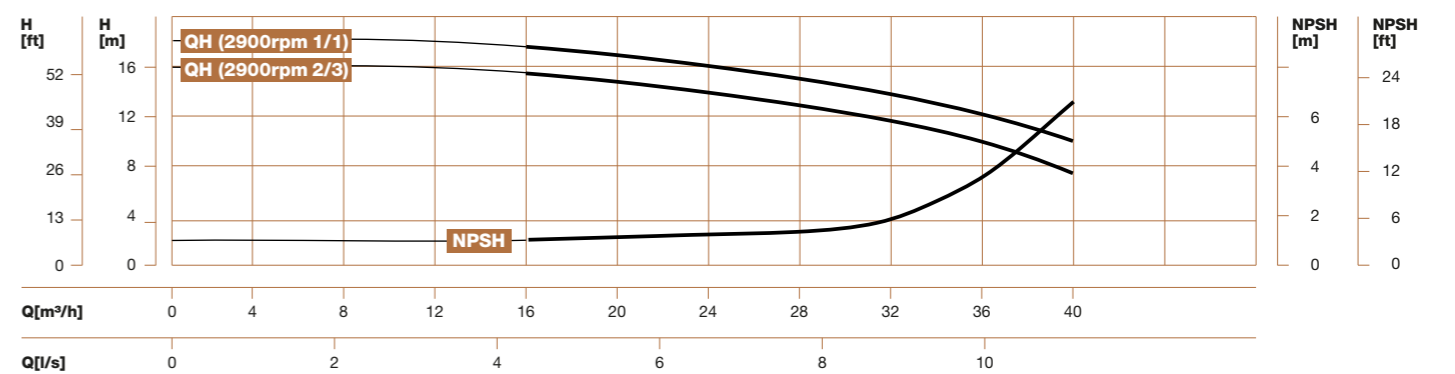
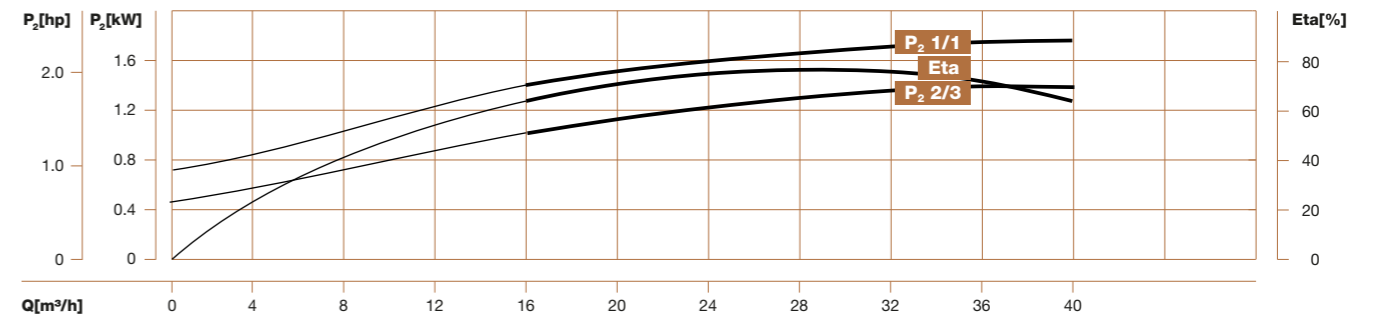
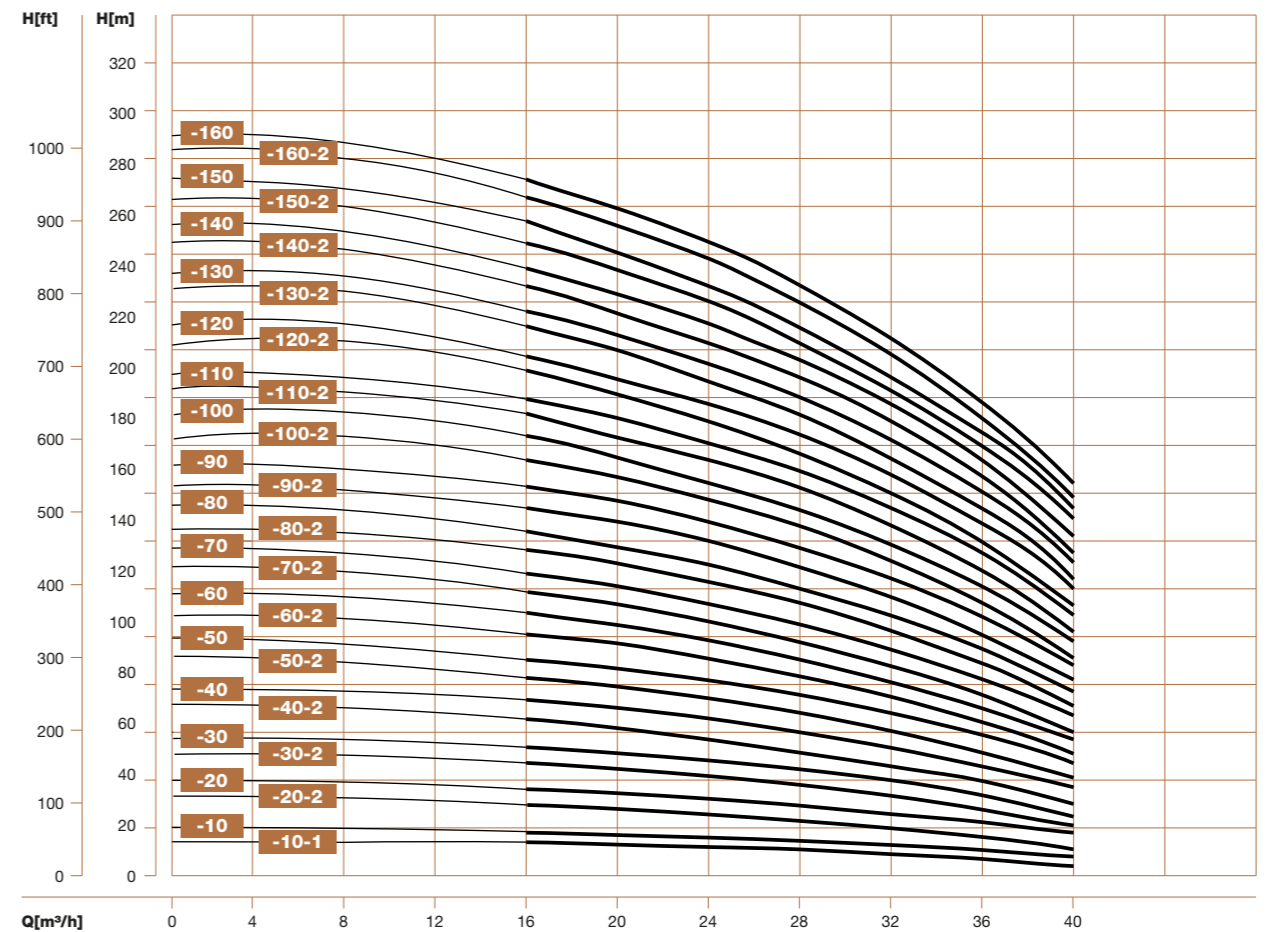

VDR0045

Installation sketch

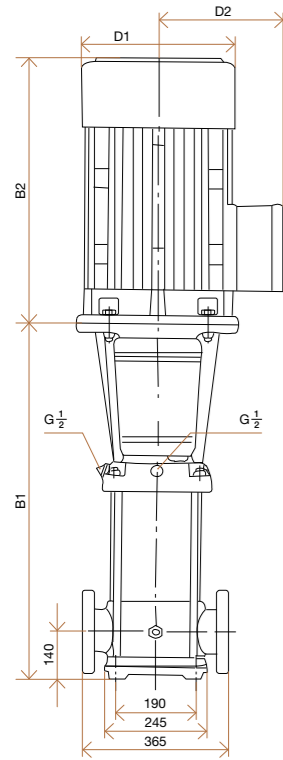

The overall dimensions of the single-phase motor and explosion-proof motor are a little different. Please contact us for details.

PN25-40/DN80

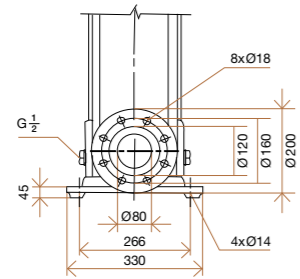

Size and weight

Model	Pump and motor dimensions					Weight (kg)
	B1	B2	B	D1	D2	
VF, VX, VN, VD-45-10	561	345/355	906/916	197/230	165/188	83/90
VF, VX, VN, VD-45-20-2/45-20	641	390	1031	260	208	105/110
VF, VX, VN, VD-45-30-2/45-30	826	500	1326	330	255	183
VF, VX, VN, VD-45-40-2/45-40	906	500	1406	330	255	197
VF, VX, VN, VD-45-50-2/45-50	986	550	1536	330	255	221
VF, VX, VN, VD-45-60-2/45-60	1066	575	1641	360	285	261
VF, VX, VN, VD-45-70-2/45-70	1146	650	1796	400	310	320
VF, VX, VN, VD-45-80-2/45-80	1226	650	1876	400	310	324
VF, VX, VN, VD-45-90-2/45-90	1306	650	1956	400	310	328/352
VF, VX, VN, VD-45-100-2/45-100	1386	650	2036	400	310	355
VF, VX, VN, VD-45-110-2/45-110	1466	685	2151	450	345	426
VF, VX, VN, VD-45-120-2/45-120	1546	685	2231	450	345	432
VF, VX, VN, VD-45-130-2	1626	685	2311	450	345	438

Performance table

Model	Driving motor		Q (m³/h)	25	30	35	40	42	45	50	55
	(kW)	(hp)									
VF, VX, VN, VD-45-10	4	5,5	H (m)	24	26	22	21	20	19	18	16
VF, VX, VN, VD-45-20-2	5,5	7,5		40	38	36	33	32	30	27	23
VF, VX, VN, VD-45-20	7,5	10		48	46	44	42	41	39	35	31
VF, VX, VN, VD-45-30-2	11	15		63	31	58	54	52	50	44	38
VF, VX, VN, VD-45-30	11	15		71	69	66	63	61	58	53	47
VF, VX, VN, VD-45-40-2	15	20		87	84	80	75	73	69	62	54
VF, VX, VN, VD-45-40	15	20		95	92	88	84	81	78	71	62
VF, VX, VN, VD-45-50-2	18,5	25		111	107	102	96	93	88	80	69
VF, VX, VN, VD-45-50	18,5	25		119	115	110	105	101	97	88	78
VF, VX, VN, VD-45-60-2	22	30		135	130	124	117	113	108	97	85
VF, VX, VN, VD-45-60	22	30		143	138	132	125	122	116	106	93
VF, VX, VN, VD-45-70-2	30	40		158	152	146	138	134	127	115	100
VF, VX, VN, VD-45-70	30	40		166	161	154	146	142	135	124	109
VF, VX, VN, VD-45-80-2	30	40		182	175	168	159	154	146	133	116
VF, VX, VN, VD-45-80	30	40		190	184	176	167	162	154	141	124
VF, VX, VN, VD-45-90-2	30	40		205	198	190	180	174	166	150	132
VF, VX, VN, VD-45-90	37	50		214	207	198	188	183	174	159	140
VF, VX, VN, VD-45-100-2	37	50		230	221	212	200	194	185	168	147
VF, VX, VN, VD-45-100	37	50		238	230	220	209	203	193	177	155
VF, VX, VN, VD-45-110-2	45	60		255	246	236	223	217	206	188	165
VF, VX, VN, VD-45-110	45	60	263	255	244	232	225	214	196	173	
VF, VX, VN, VD-45-120-2	45	60	280	270	259	245	238	226	206	181	
VF, VX, VN, VD-45-120	45	60	289	280	268	255	247	236	216	190	
VF, VX, VN, VD-45-130-2	45	60	305	294	282	267	259	247	225	198	

Performance curve ISO9906:2012 Grade 3B

VDR0045 50Hz

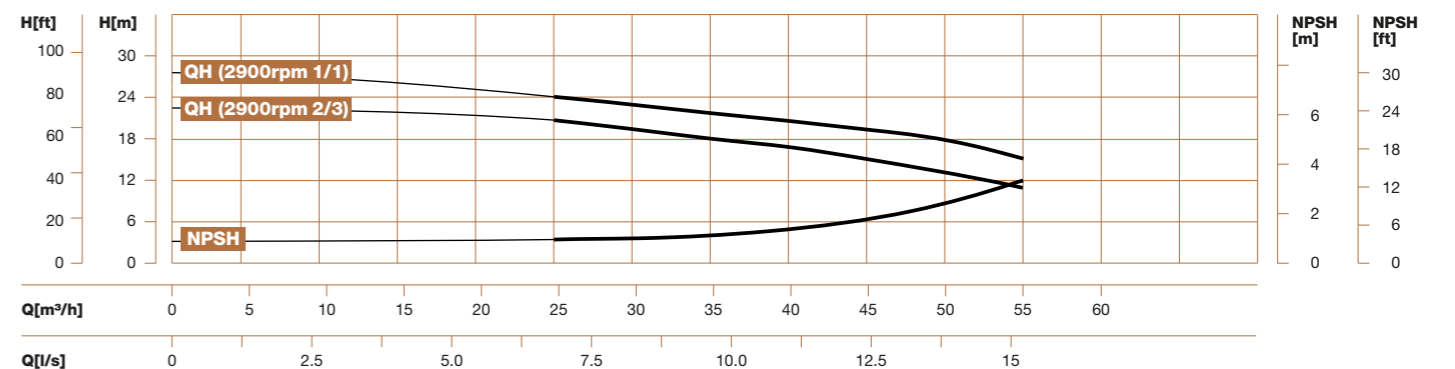
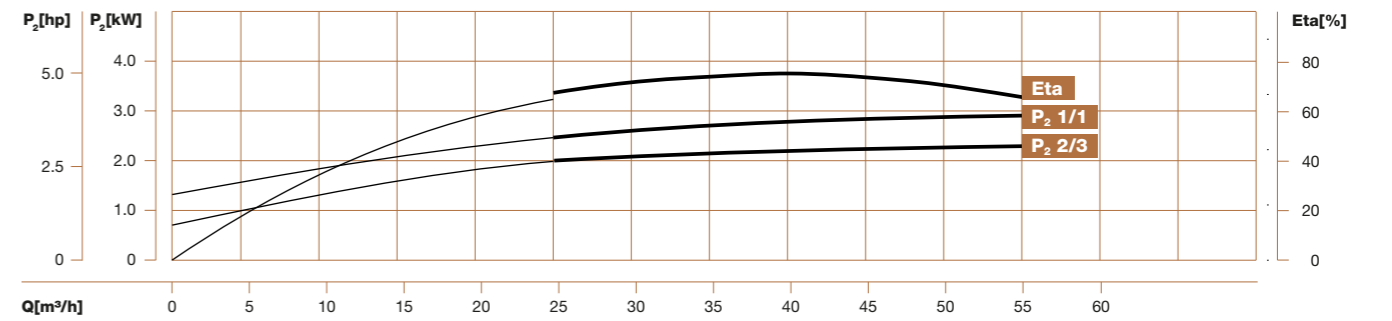
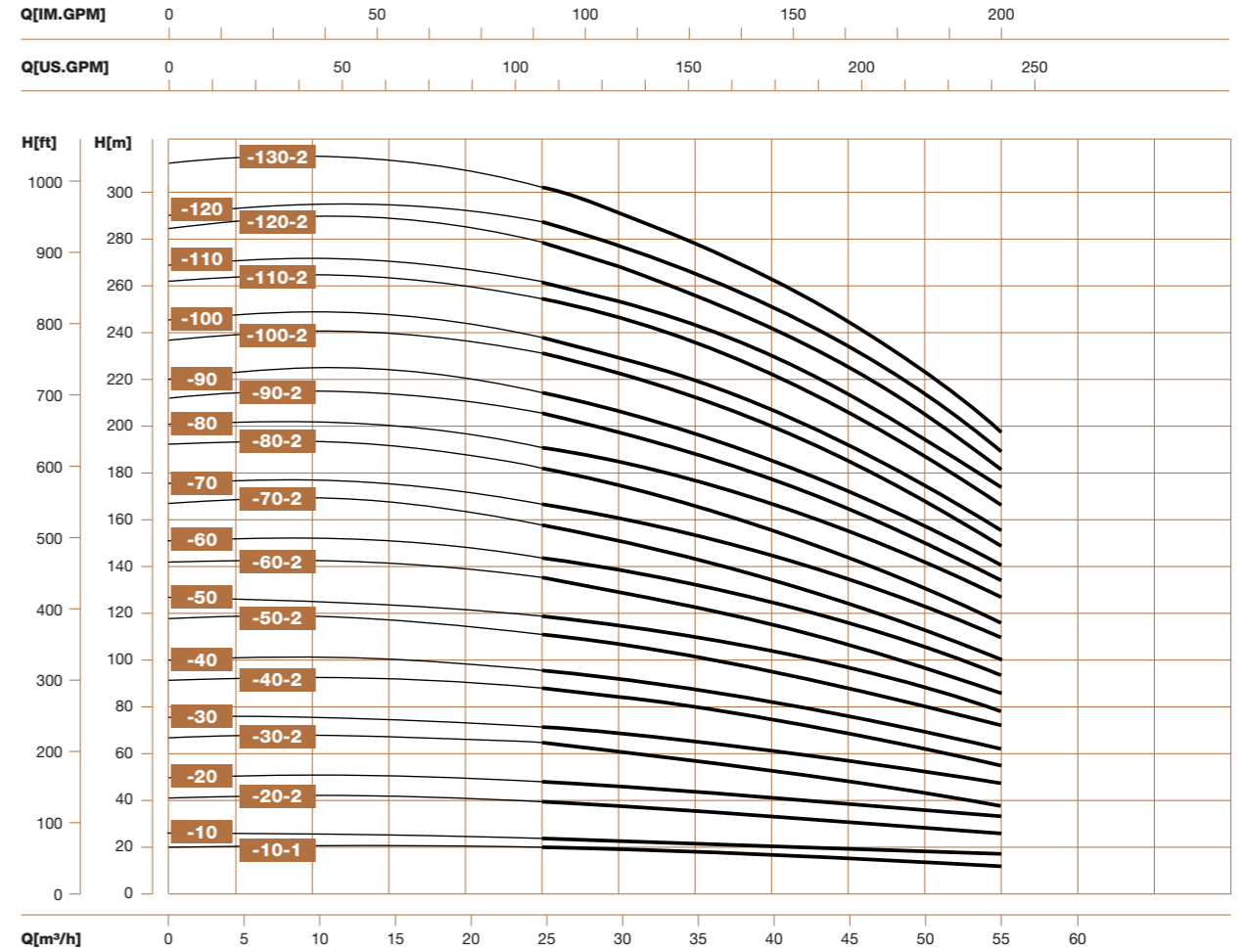

VDR0065

Installation sketch

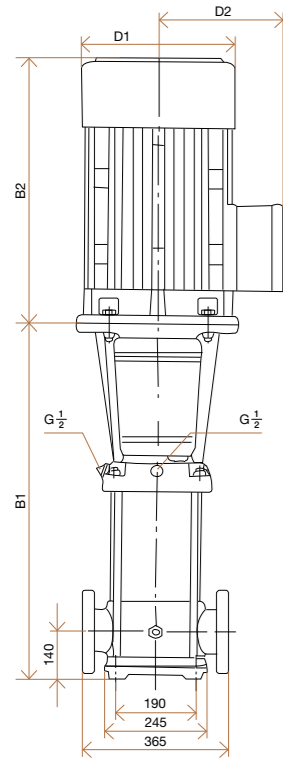

The overall dimensions of the single-phase motor and explosion-proof motor are a little different. Please contact us for details.

PN25-40/DN100 standard flange is also available if required for VX, VN, VD versions.

PN16/DN100

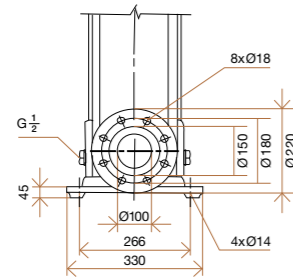

Size and weight

Model	Pump and motor dimensions					Weight (kg)
	B1	B2	B	D1	D2	
VF, VX, VN, VD-65-10-1	561	335	916	230	188	93
VF, VX, VN, VD-65-10	561	390	951	260	208	105
VF, VX, VN, VD-65-20-2	644	390	1034	260	208	110
VF, VX, VN, VD-65-20-1	754	500	1254	330	255	182
VF, VX, VN, VD-65-20	754	500	1254	330	255	182
VF, VX, VN, VD-65-30-2	836	500	1336	330	255	196
VF, VX, VN, VD-65-30-1	836	500	1336	330	255	197
VF, VX, VN, VD-65-30	836	550	1386	330	255	221
VF, VX, VN, VD-65-40-2	919	550	1469	330	255	225
VF, VX, VN, VD-65-40-1	919	575	1494	360	285	258
VF, VX, VN, VD-65-40	919	575	1494	360	285	258
VF, VX, VN, VD-65-50-2	1001	650	1651	400	310	319
VF, VX, VN, VD-65-50-1	1001	650	1651	400	310	319
VF, VX, VN, VD-65-50	1001	650	1651	400	310	320
VF, VX, VN, VD-65-60-2	1084	650	1734	400	310	325
VF, VX, VN, VD-65-60-1	1084	650	1734	400	310	349
VF, VX, VN, VD-65-60	1084	650	1374	400	310	349
VF, VX, VN, VD-65-70-2	1166	650	1816	400	310	353
VF, VX, VN, VD-65-70-1	1166	650	1816	400	310	353
VF, VX, VN, VD-65-70	1166	685	1851	460	340	420
VF, VX, VN, VD-65-80-2	1248	685	1933	460	340	424
VF, VX, VN, VD-65-80-1	1248	685	1933	460	340	424

Performance table

Model	Driving motor		Q (m³/h)	30	40	50	60	65	70	80
	(kW)	(hp)								
VF, VX, VN, VD-65-10-1	4	5,5	H (m)	19	18	16	14	13	11	8
VF, VX, VN, VD-65-10	5,5	7,5		27	25	23	21	20	18	15
VF, VX, VN, VD-65-20-2	7,5	10		39	36	33	29	26	23	17
VF, VX, VN, VD-65-20-1	11	15		46	44	40	36	33	30	24
VF, VX, VN, VD-65-20	11	15		53	51	47	43	40	37	30
VF, VX, VN, VD-65-30-2	15	20		66	62	56	50	45	41	32
VF, VX, VN, VD-65-30-1	15	20		73	69	63	57	53	48	39
VF, VX, VN, VD-65-30	18,5	25		80	76	70	64	60	55	46
VF, VX, VN, VD-65-40-2	18,5	25		92	87	80	71	66	60	47
VF, VX, VN, VD-65-40-1	22	30		100	94	87	78	73	67	54
VF, VX, VN, VD-65-40	22	30		107	101	94	85	80	74	61
VF, VX, VN, VD-65-50-2	30	40		121	114	105	95	88	80	64
VF, VX, VN, VD-65-50-1	30	40		128	121	112	102	95	87	71
VF, VX, VN, VD-65-50	30	40		136	129	119	109	102	94	78
VF, VX, VN, VD-65-60-2	30	40		150	142	131	118	110	101	81
VF, VX, VN, VD-65-60-1	37	50		157	149	138	125	117	108	88
VF, VX, VN, VD-65-60	37	50		164	156	145	132	124	115	95
VF, VX, VN, VD-65-70-2	37	50		179	169	156	141	132	121	99
VF, VX, VN, VD-65-70-1	37	50		186	176	163	148	139	128	106
VF, VX, VN, VD-65-70	45	60		193	183	170	155	146	135	112
VF, VX, VN, VD-65-80-2	45	60		207	196	182	164	154	142	116
VF, VX, VN, VD-65-80-1	45	60	215	203	189	171	161	149	123	

Performance curve ISO9906:2012 Grade 3B

VDR0065 50Hz

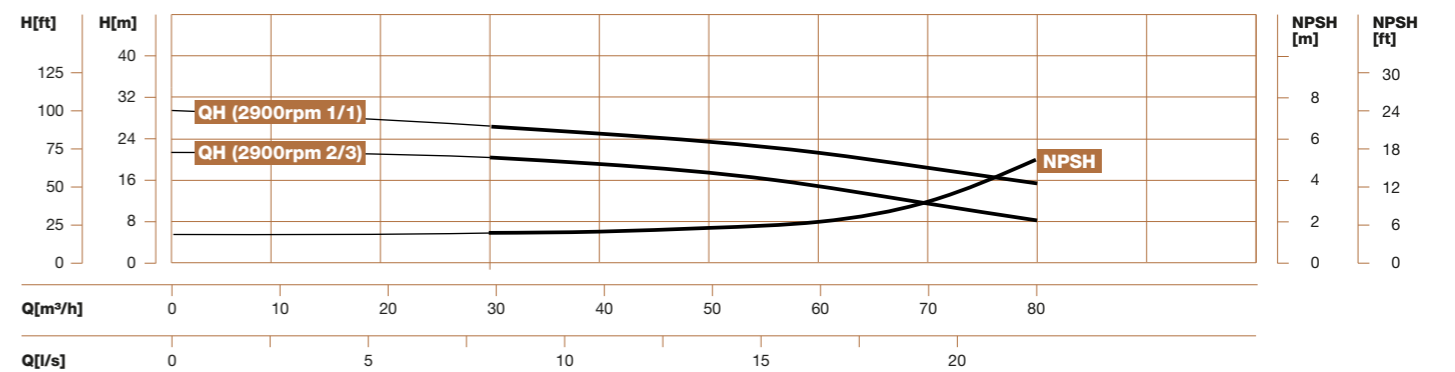
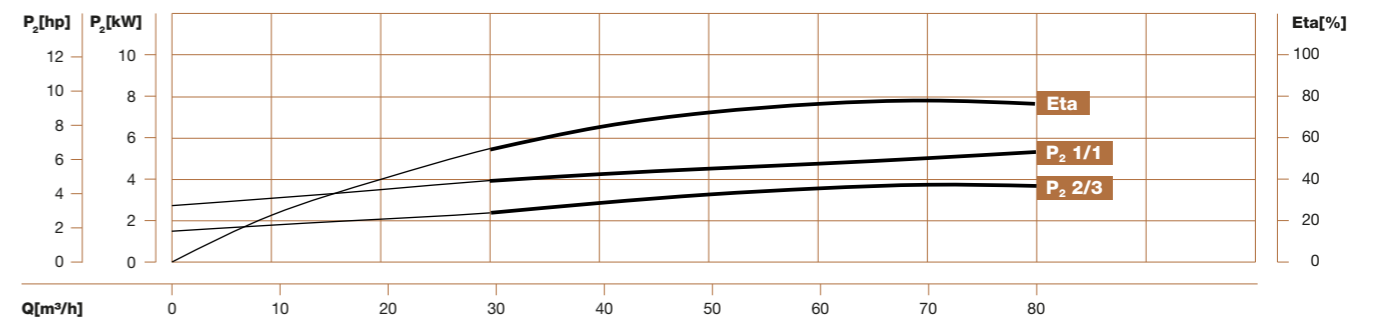
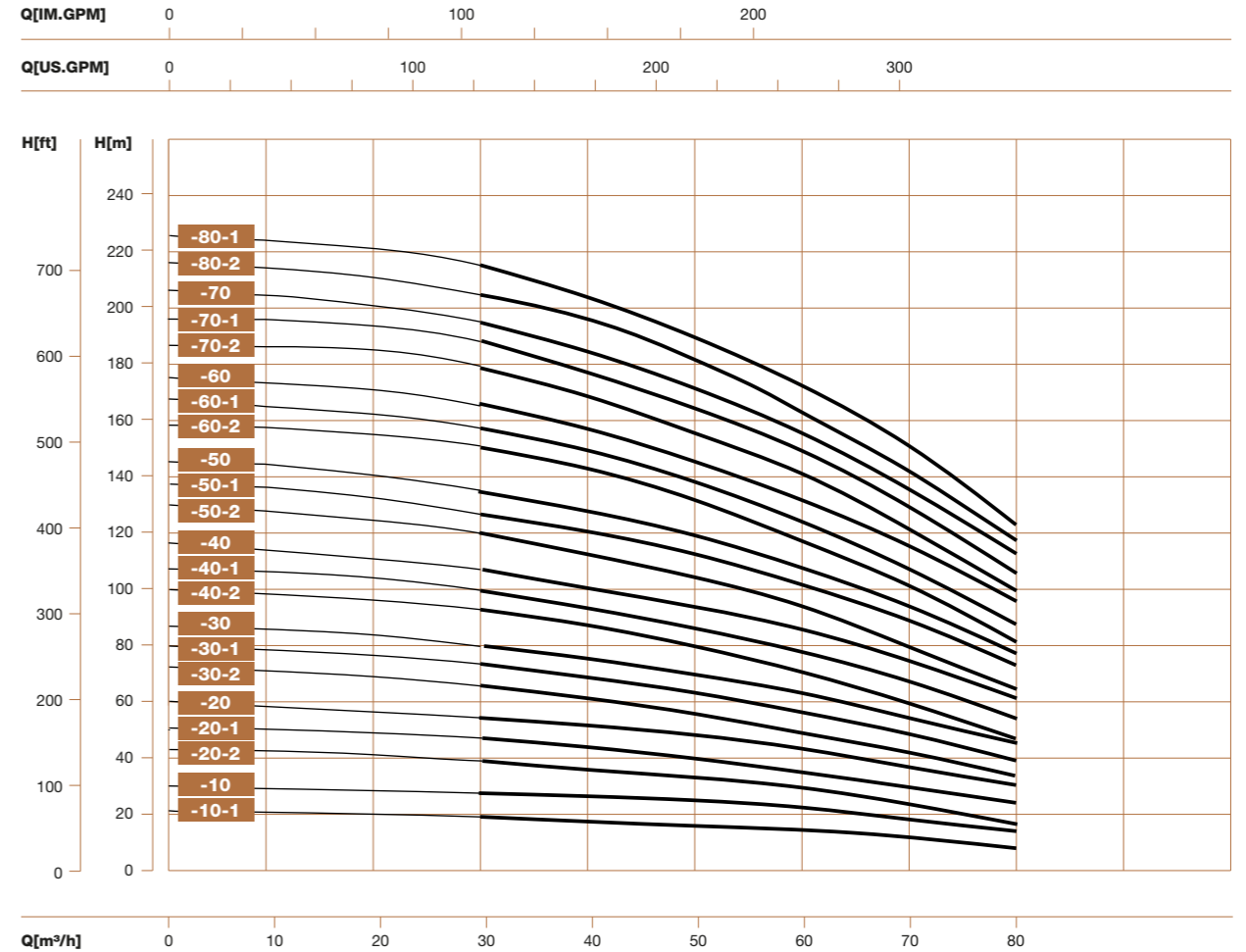

VDRO090

Installation sketch

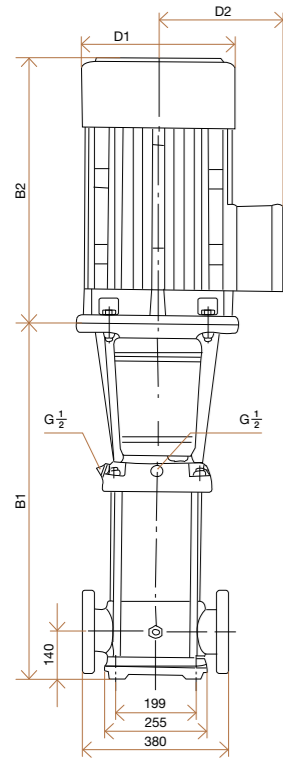

The overall dimensions of the single-phase motor and explosion-proof motor are a little different. Please contact us for details.

PN25-40/DN100 standard flange is also available if required for VX, VN, VD versions.

PN16/DN100

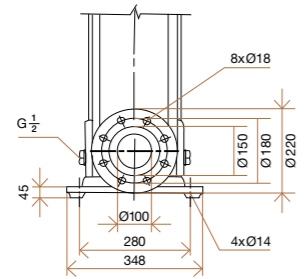

Size and weight

Model	Pump and motor dimensions					Weight (kg)
	B1	B2	B	D1	D2	
VF, VX, VN, VD-90-10-1	571	390	961	260	208	105
VF, VX, VN, VD-90-10	571	390	961	260	208	110
VF, VX, VN, VD-90-20-2	773	500	1273	330	255	181
VF, VX, VN, VD-90-20	773	500	1273	330	255	192
VF, VX, VN, VD-90-30-2	865	550	1415	330	255	215
VF, VX, VN, VD-90-30	865	575	1440	360	285	252
VF, VX, VN, VD-90-40-2	957	650	1607	400	310	312
VF, VX, VN, VD-90-40	957	650	1607	400	310	312
VF, VX, VN, VD-90-50-2	1049	650	1699	400	310	336
VF, VX, VN, VD-90-50	1049	650	1699	400	310	336
VF, VX, VN, VD-90-60-2	1141	685	1826	460	340	407
VF, VX, VN, VD-90-60	1141	685	1826	460	340	407

Performance curve ISO9906:2012 Grade 3B

VDRO090 50Hz

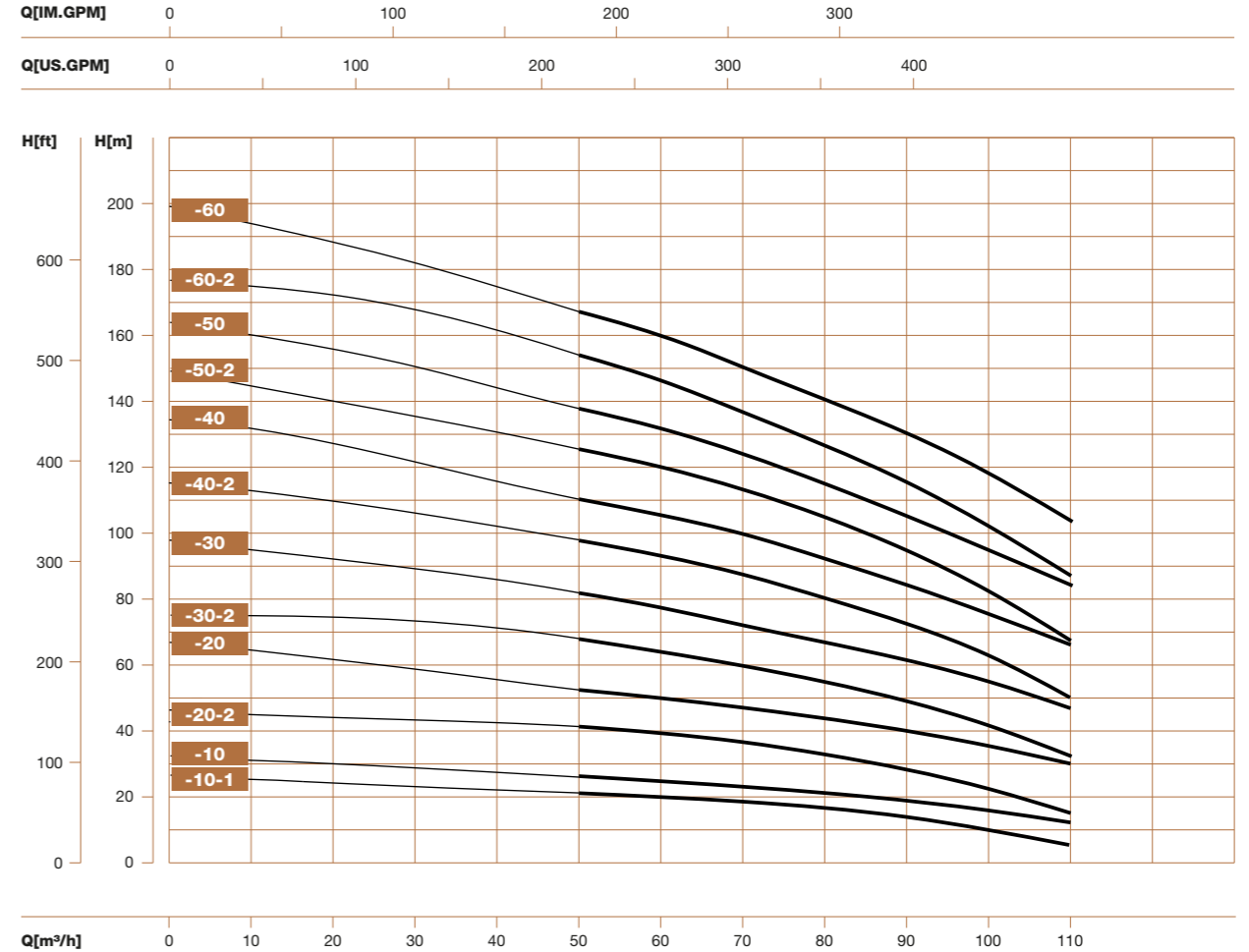

Performance table

Model	Driving motor		Q (m³/h)	50	60	70	80	85	90	100	110
	(kW)	(hp)									
VF, VX, VN, VD-90-10-1	5,5	7,5	H (m)	22	19	17	16	14	13	10	6
VF, VX, VN, VD-90-10	7,5	10		25	24	22	21	20	19	16	12
VF, VX, VN, VD-90-20-2	11	15		41	39	36	32	30	28	22	15
VF, VX, VN, VD-90-20	15	20		53	50	47	44	41	40	36	30
VF, VX, VN, VD-90-30-2	18,5	25		68	65	60	55	52	49	41	32
VF, VX, VN, VD-90-30	22	30		81	77	72	67	64	62	55	48
VF, VX, VN, VD-90-40-2	30	40		98	93	87	80	75	72	62	50
VF, VX, VN, VD-90-40	30	40		110	105	100	92	86	84	76	66
VF, VX, VN, VD-90-50-2	37	50		126	120	113	104	98	93	81	68
VF, VX, VN, VD-90-50	37	50		139	131	124	115	110	106	94	83
VF, VX, VN, VD-90-60-2	45	60		155	148	139	129	122	117	102	85
VF, VX, VN, VD-90-60	45	60		168	160	150	141	134	130	117	103

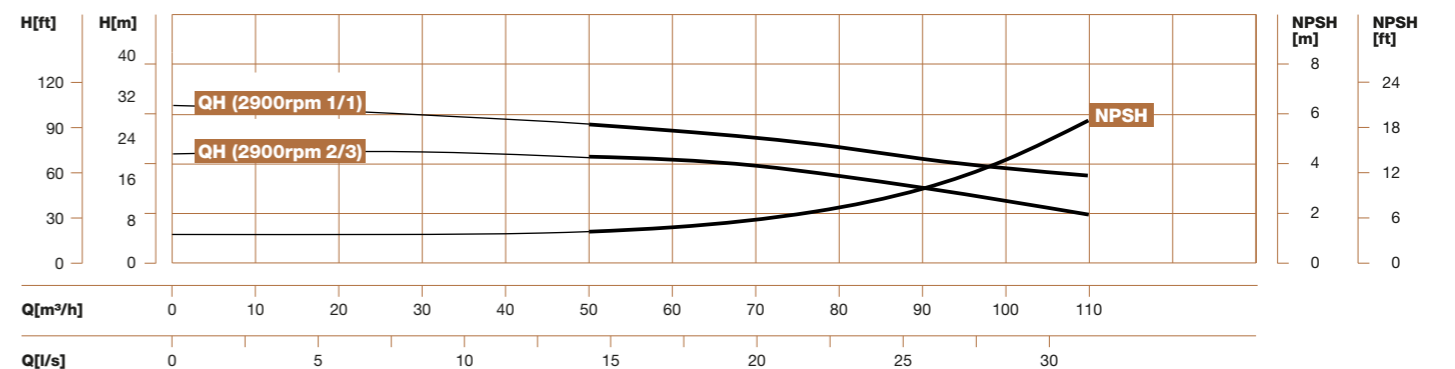
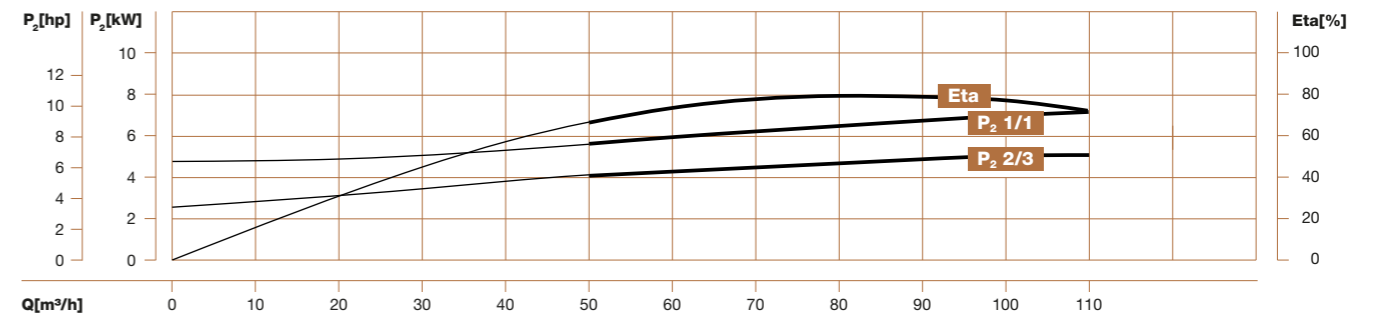

VDR00125

Installation sketch

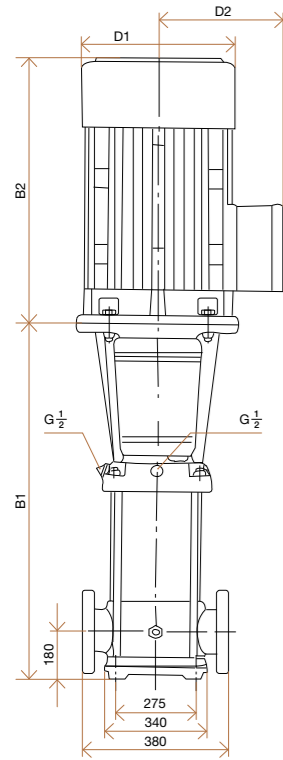

The overall dimensions of the single-phase motor and explosion-proof motor are a little different. Please contact us for details.

PN25-40/DN125

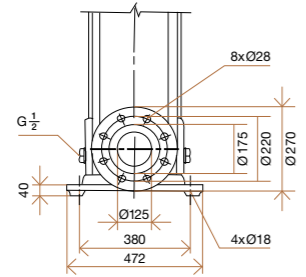

Size and weight

Model	Pump and motor dimensions					Weight (kg)
	B1	B2	B	D1	D2	
VF, VX, VN, VD-125-10	840	500	1340	330	255	230
VF, VX, VN, VD-125-20-2	1000	500	1500	330	255	245
VF, VX, VN, VD-125-20-1	1000	550	1550	330	255	250
VF, VX, VN, VD-125-20	1000	575	1575	360	285	285
VF, VX, VN, VD-125-30-2	1160	650	1810	400	310	360
VF, VX, VN, VD-125-30-1	1160	650	1810	400	310	360
VF, VX, VN, VD-125-30	1160	650	1810	400	310	360
VF, VX, VN, VD-125-40-2	1320	650	1970	400	310	400
VF, VX, VN, VD-125-40-1	1320	650	1970	400	310	400
VF, VX, VN, VD-125-40	1320	685	2005	400	340	460
VF, VX, VN, VD-125-50-2	1480	685	2165	460	340	470
VF, VX, VN, VD-125-50-1	1480	685	2165	460	340	470
VF, VX, VN, VD-125-50	1510	760	2270	460	370	575
VF, VX, VN, VD-125-60-2	1670	760	2430	540	370	585
VF, VX, VN, VD-125-60-1	1670	760	2430	540	370	585
VF, VX, VN, VD-125-60	1670	845	2515	540	410	705
VF, VX, VN, VD-125-70-2	1830	845	2675	580	410	715
VF, VX, VN, VD-125-70-1	1830	845	2675	580	410	715
VF, VX, VN, VD-125-70	1830	845	2675	580	410	715

Performance table

Model	Driving motor		Q (m³/h)	60	70	80	90	100	110	120	130	140	150
	(kW)	(hp)											
VF, VX, VN, VD-125-10	11	15		22	21,8	21,6	21	20,5	19,5	18,5	17	16	15
VF, VX, VN, VD-125-20-2	15	20		34	33,6	33	31	30,2	30	28,5	28	25	24
VF, VX, VN, VD-125-20-1	18,5	25		41	40	39,5	38,5	37	36,5	34,5	32,5	30	27,5
VF, VX, VN, VD-125-20	22	30		46	45	44,5	43,5	42,4	41	40	38	36	33,5
VF, VX, VN, VD-125-30-2	30	40		57	56	55	53,5	52	51	49	46,5	43,5	41
VF, VX, VN, VD-125-30-1	30	40		64	63	62	60	58,5	57,5	55,5	52	49	46
VF, VX, VN, VD-125-30	30	40		69,5	68,5	67,5	66	64	62,5	61	57,5	54,5	51
VF, VX, VN, VD-125-40-2	37	50		80,5	79	78	76	73,5	72	69	66	61,5	58
VF, VX, VN, VD-125-40-1	37	50		87	86	84,5	82	80	78	76	72	68	64,5
VF, VX, VN, VD-125-40	45	60	H (m)	92,5	91	90	88	85,5	83	81	77	73	68,5
VF, VX, VN, VD-125-50-2	45	60		104,5	103	101	99	96	93	90	85,5	80,5	75,5
VF, VX, VN, VD-125-50-1	45	60		110,5	109	107,5	105	102	100	97	90	86,5	83
VF, VX, VN, VD-125-50	55	75		115,5	114	113	110	107,5	104,5	101,5	96	91	86
VF, VX, VN, VD-125-60-2	55	75		128	125,5	123	121	117,3	113,5	110	104,5	98,5	92,5
VF, VX, VN, VD-125-60-1	55	75		134	132	130,5	127	124	121	118	111	105	100
VF, VX, VN, VD-125-60	75	100		139	137	135	132	128,8	126	123	116	110	104
VF, VX, VN, VD-125-70-2	75	100		151	148	145,5	143	139,6	134	130	123,5	116,5	109
VF, VX, VN, VD-125-70-1	75	100		156,5	154	152	148,5	144,5	141	137,5	130	123	116,5
VF, VX, VN, VD-125-70	75	100		162,5	160,5	158,5	155	151	148	145	137	129	123

Performance curve ISO9906:2012 Grade 3B

VDR00125 50Hz

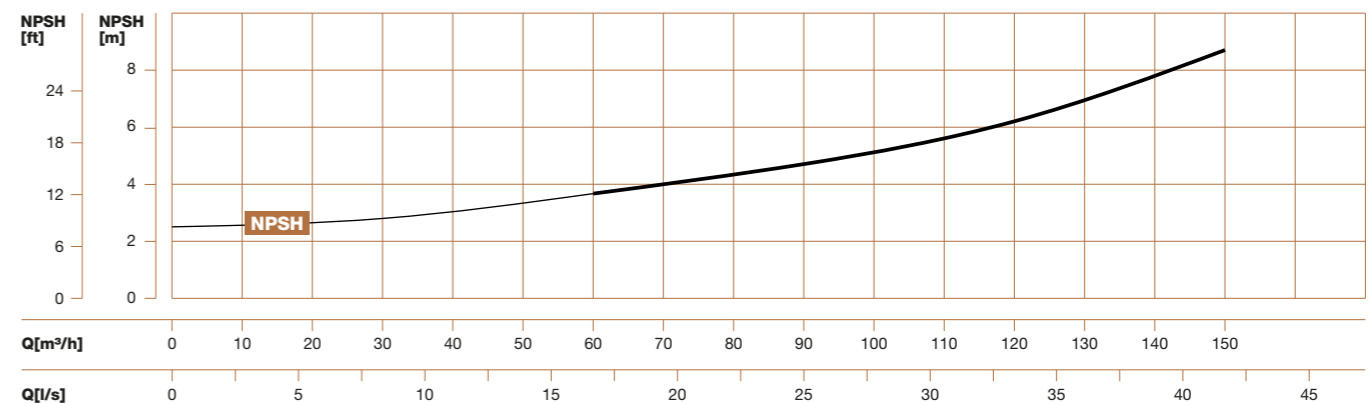
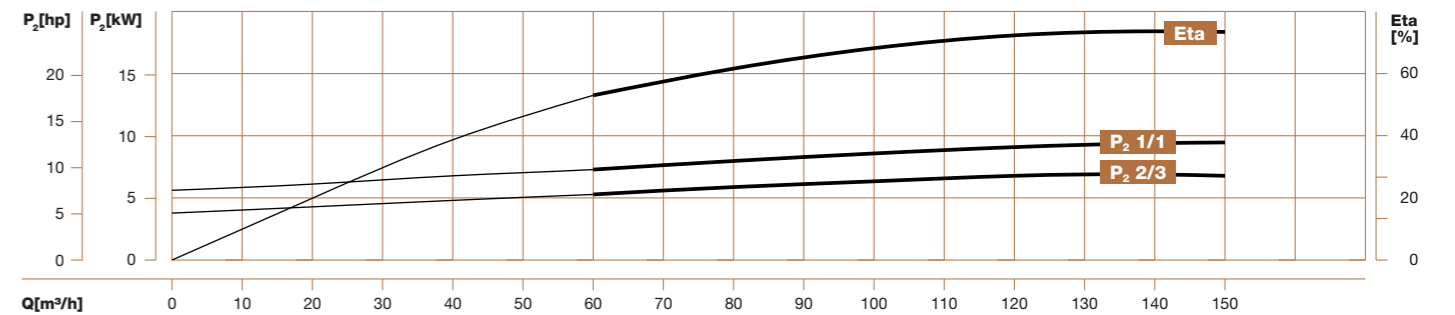
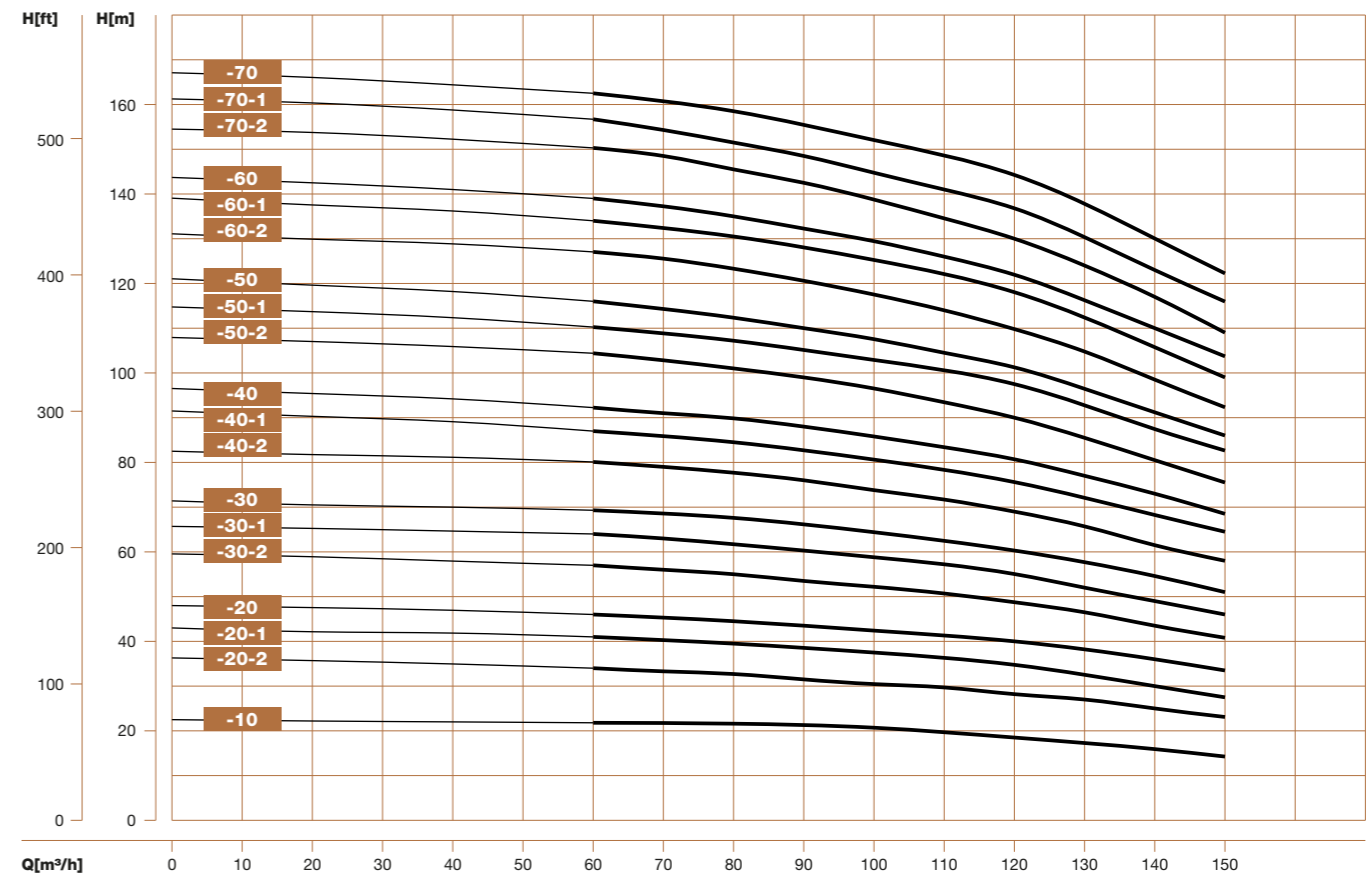

VDR00150

Installation sketch

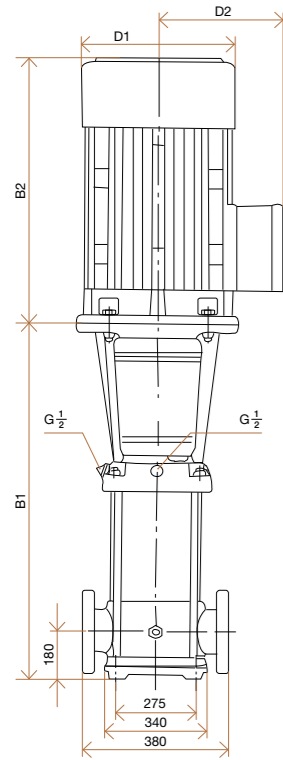

The overall dimensions of the single-phase motor and explosion-proof motor are a little different. Please contact us for details.

PN25-40/DN125

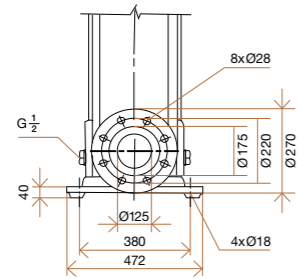

Size and weight

Model	Pump and motor dimensions					Weight (kg)
	B1	B2	B	D1	D2	
VF, VX, VN, VD-150-10-1	840	500	1340	330	255	230
VF, VX, VN, VD-150-10	840	500	1340	330	255	235
VF, VX, VN, VD-150-20-2	1000	550	1550	330	255	250
VF, VX, VN, VD-150-20-1	1000	575	1575	360	285	295
VF, VX, VN, VD-150-20	1000	650	1650	400	310	350
VF, VX, VN, VD-150-30-2	1160	650	1810	400	310	360
VF, VX, VN, VD-150-30-1	1160	650	1810	400	310	360
VF, VX, VN, VD-150-30	1160	650	1810	400	310	385
VF, VX, VN, VD-150-40-2	1320	685	2005	460	310	460
VF, VX, VN, VD-150-40-1	1320	685	2005	460	340	460
VF, VX, VN, VD-150-40	1350	760	2110	540	340	560
VF, VX, VN, VD-150-50-2	1510	760	2270	540	370	570
VF, VX, VN, VD-150-50-1	1510	845	2355	580	410	690
VF, VX, VN, VD-150-50	1510	845	2355	580	410	690
VF, VX, VN, VD-150-60-2	1670	845	2515	580	410	700
VF, VX, VN, VD-150-60-1	1670	845	2515	580	410	700
VF, VX, VN, VD-150-60	1670	845	2515	580	410	700

Performance table

Model	Driving motor		Q (m³/h)	H (m)												
	(kW)	(hp)		80	90	100	110	120	130	140	150	160	170	180		
VF, VX, VN, VD-150-10-1	11	15		18,3	17,8	17,3	17	16	15	14	12,5	11	10	8,5		
VF, VX, VN, VD-150-10	15	20		24	23	22,5	22	21,5	20,5	20	18,5	17	16	15		
VF, VX, VN, VD-150-20-2	18,5	25		37	35,5	34	33	32	31	29	27,5	26	23	21		
VF, VX, VN, VD-150-20-1	22	30		44,3	43	43	40	39	38,5	37,5	35	33	30	27		
VF, VX, VN, VD-150-20	30	40		50	49	48	47	45,5	44	42	40	37	34	32		
VF, VX, VN, VD-150-30-2	30	40		63,5	61	59	57,5	56	54,5	53	49	45,5	42	39		
VF, VX, VN, VD-150-30-1	37	50		70	68	67	65	63	62	60	56	53	49	45		
VF, VX, VN, VD-150-30	37	50		78	76,5	75	73	70,5	68	66	63	59	55	50,5		
VF, VX, VN, VD-150-40-2	45	60	H (m)	89	87	84	81,5	79	77	74,5	70,5	65,5	60	56		
VF, VX, VN, VD-150-40-1	45	60		96,5	94	91,5	89	86,5	84	81,5	77	72,5	67	62		
VF, VX, VN, VD-150-40	55	75		104	102	100	97	95	91	88	84	79,5	74	68		
VF, VX, VN, VD-150-50-2	55	75		115,5	112	109	106	102,5	100	97	92	86	79	73,5		
VF, VX, VN, VD-150-50-1	75	100		122,5	119,5	117	113,5	111,5	107,5	104,5	99	93,5	87	80		
VF, VX, VN, VD-150-50	75	100		130	127,5	125	121	119	115	111,5	106,5	101	94,5	86,5		
VF, VX, VN, VD-150-60-2	75	100		140	137	133	130	126	121	118	112	106	98	91		
VF, VX, VN, VD-150-60-1	75	100		148,5	145	141,7	137,5	135	131	127	120,5	114,5	106,5	97,5		
VF, VX, VN, VD-150-60	75	100		157	153	149	145	142	139,5	137	130	123,5	116	109		

Performance curve ISO9906:2012 Grade 3B

VDR00150 50Hz

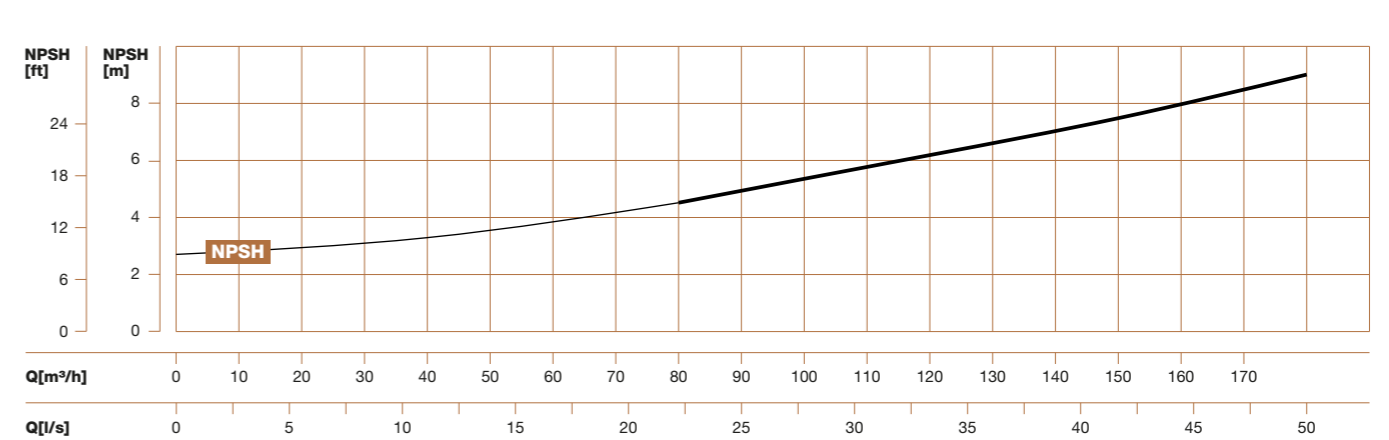
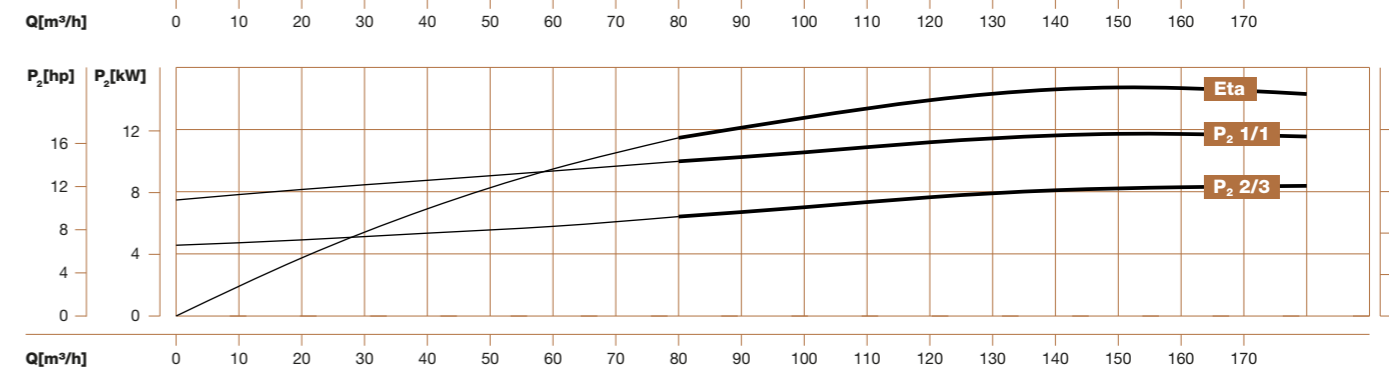
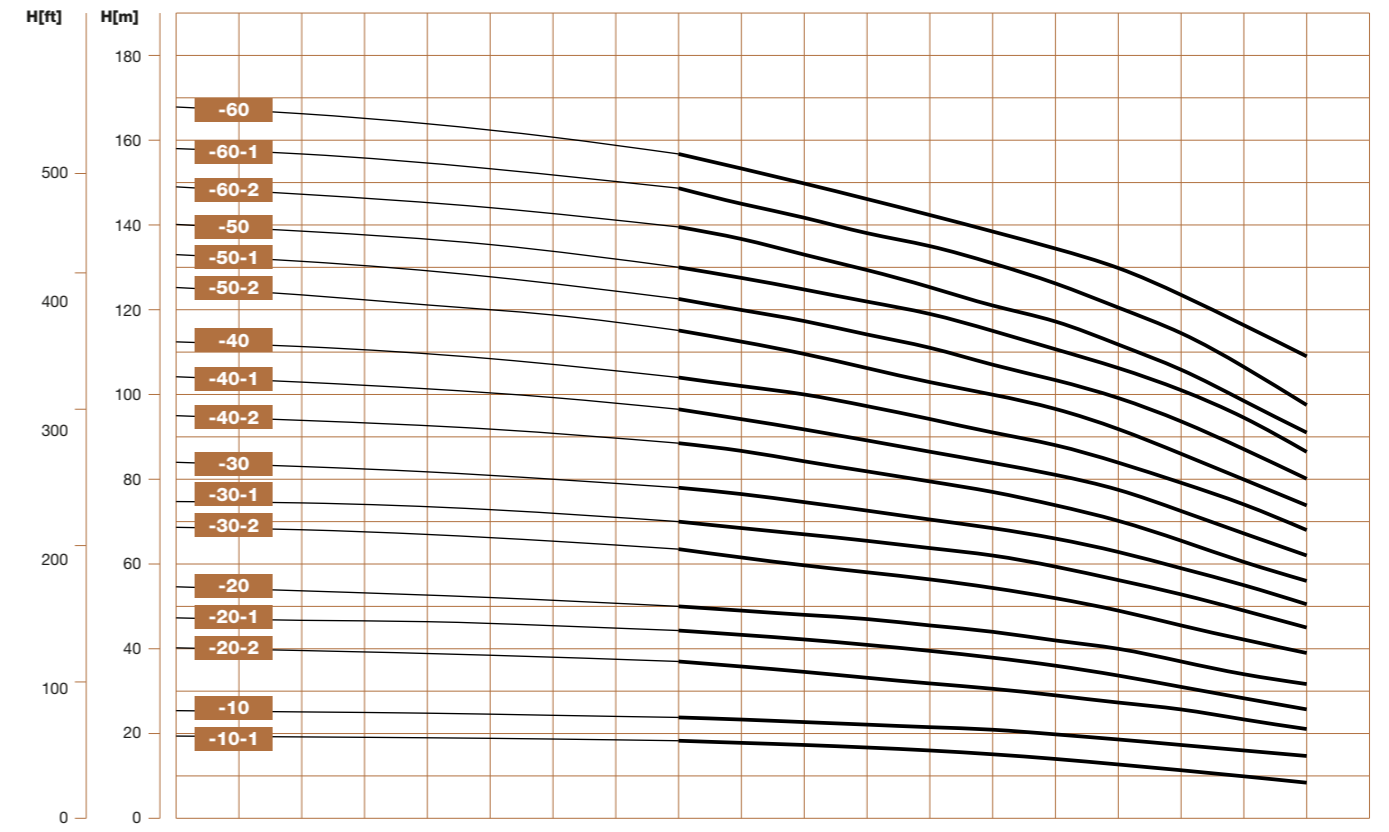
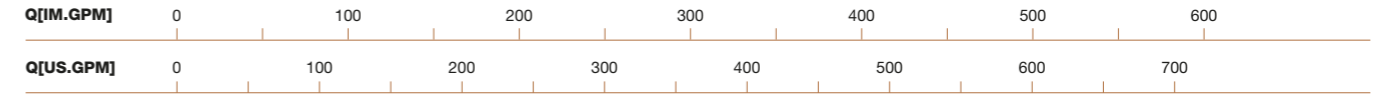

VDR00210

Installation sketch

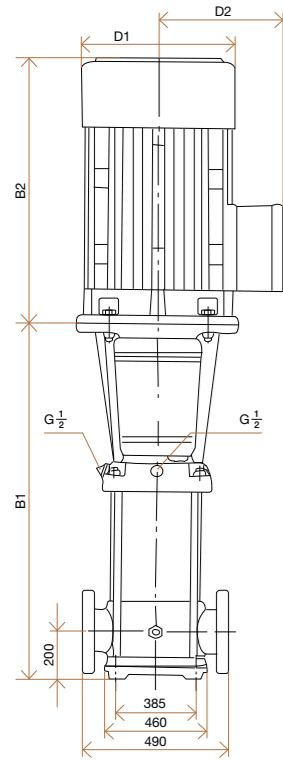

The overall dimensions of the an explosion-proof motor are a little different. Please contact us for details.

PN25-40/DN150

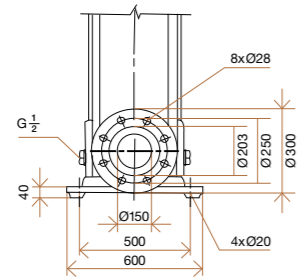

Size and weight

Model	Pump and motor dimensions					Weight (kg)
	B1	B2	B	D1	D2	
VF, VX, VN, VD-210-10-B	907	550	1457	330	255	311
VF, VX, VN, VD-210-10-A	907	575	1482	360	285	347
VF, VX, VN, VD-210-10	907	650	1557	400	310	403
VF, VX, VN, VD-210-20-2B	1101	650	1751	400	310	447
VF, VX, VN, VD-210-20-2A	1101	685	1786	460	340	504
VF, VX, VN, VD-210-20-A	1131	760	1891	540	370	595
VF, VX, VN, VD-210-20	1131	760	1891	540	370	595
VF, VX, VN, VD-210-30-2B	1325	845	2170	580	410	748
VF, VX, VN, VD-210-30-A-B	1325	845	2170	580	410	748
VF, VX, VN, VD-210-30-2A	1325	845	2170	580	410	748
VF, VX, VN, VD-210-30-B	1325	845	2170	580	410	748
VF, VX, VN, VD-210-30-A	1325	845	2170	580	410	748
VF, VX, VN, VD-210-30	1325	895	2220	580	410	817
VF, VX, VN, VD-210-40-2B	1519	1140	2414	580	410	830
VF, VX, VN, VD-210-40-2A	1519	1140	2659	645	550	1180
VF, VX, VN, VD-210-40-A	1519	1140	2659	645	550	1180
VF, VX, VN, VD-210-40	1519	1140	2659	645	550	1180

Performance table

Model	Driving motor		Q (m³/h)	100	120	140	160	180	200	220	240
	(kW)	(hp)									
VF, VX, VN, VD-210-10-B	18,5	25	H (m)	25,5	25	24	23	21,5	20	18	15,5
VF, VX, VN, VD-210-10-A	22	30		29	28,5	27,5	26,5	25,5	24	22	20
VF, VX, VN, VD-210-10	30	40		38,5	38	37,5	36,5	35	34	32,5	30
VF, VX, VN, VD-210-20-2B	37	50		53	51	49	47	44	41	37	32
VF, VX, VN, VD-210-20-2A	45	60		59,5	58	56	54	52,5	49	44,5	40,5
VF, VX, VN, VD-210-20-A	55	75		69	68	66	64	62	59	55,5	51
VF, VX, VN, VD-210-20	55	75		78,5	77,5	76	74	71,5	69	66	61,5
VF, VX, VN, VD-210-30-2B	75	100		91,5	89	86,5	83,5	79	75	70	63
VF, VX, VN, VD-210-30-A-B	75	100		95	93	90	87	83,5	79	73,5	67
VF, VX, VN, VD-210-30-2A	75	100		99,5	97,5	94,5	91,5	89	84	78,5	72
VF, VX, VN, VD-210-30-B	75	100		104,5	102,5	100	97	93	89	84,5	77,5
VF, VX, VN, VD-210-30-A	75	100		108	106	103,5	100,5	97,5	93	88	81,5
VF, VX, VN, VD-210-30	90	120		117,5	116	113,5	110,5	107	103	99	92
VF, VX, VN, VD-210-40-2B	90	120		131,5	129	125,5	121	115,5	110	103,5	94
VF, VX, VN, VD-210-40-2A	110	150		138,5	136	132	128	124	118	111	102,5
VF, VX, VN, VD-210-40-A	110	150		148	145,5	142,5	138	134	128	122	113
VF, VX, VN, VD-210-40	110	150	157,5	155,5	152,5	148	143,5	138	132,5	123,5	

Performance curve ISO9906:2012 Grade 3B

VDR00210 50Hz

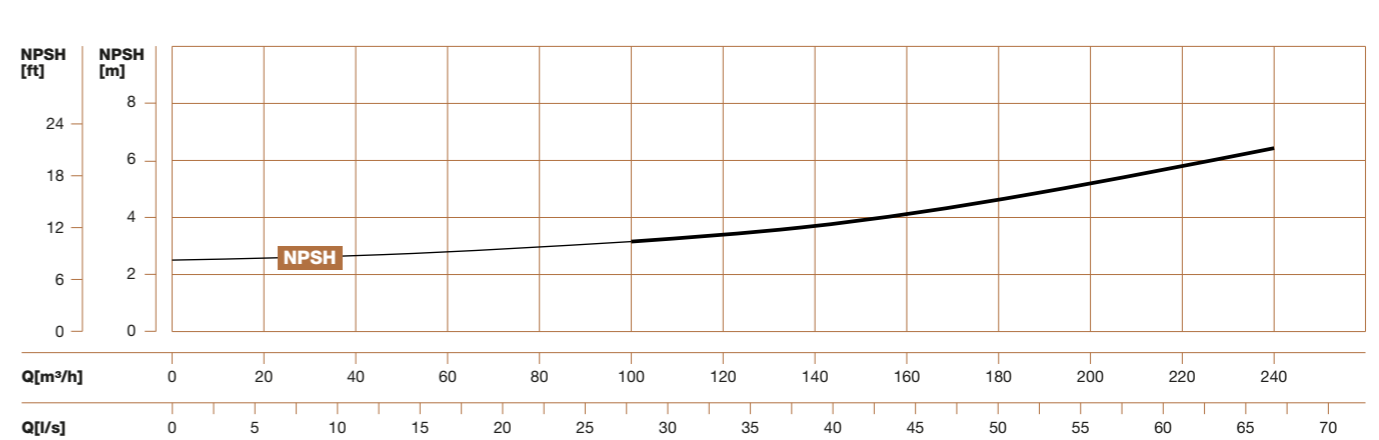
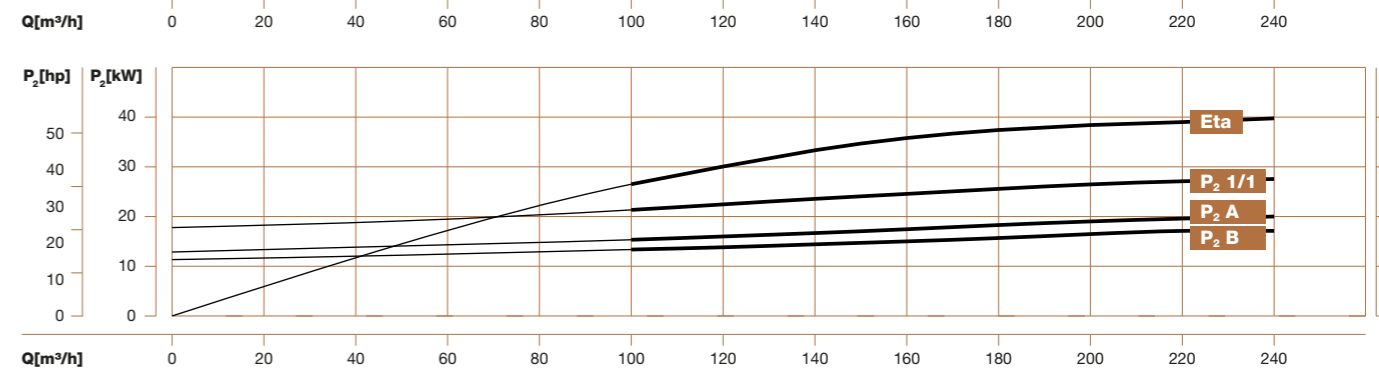
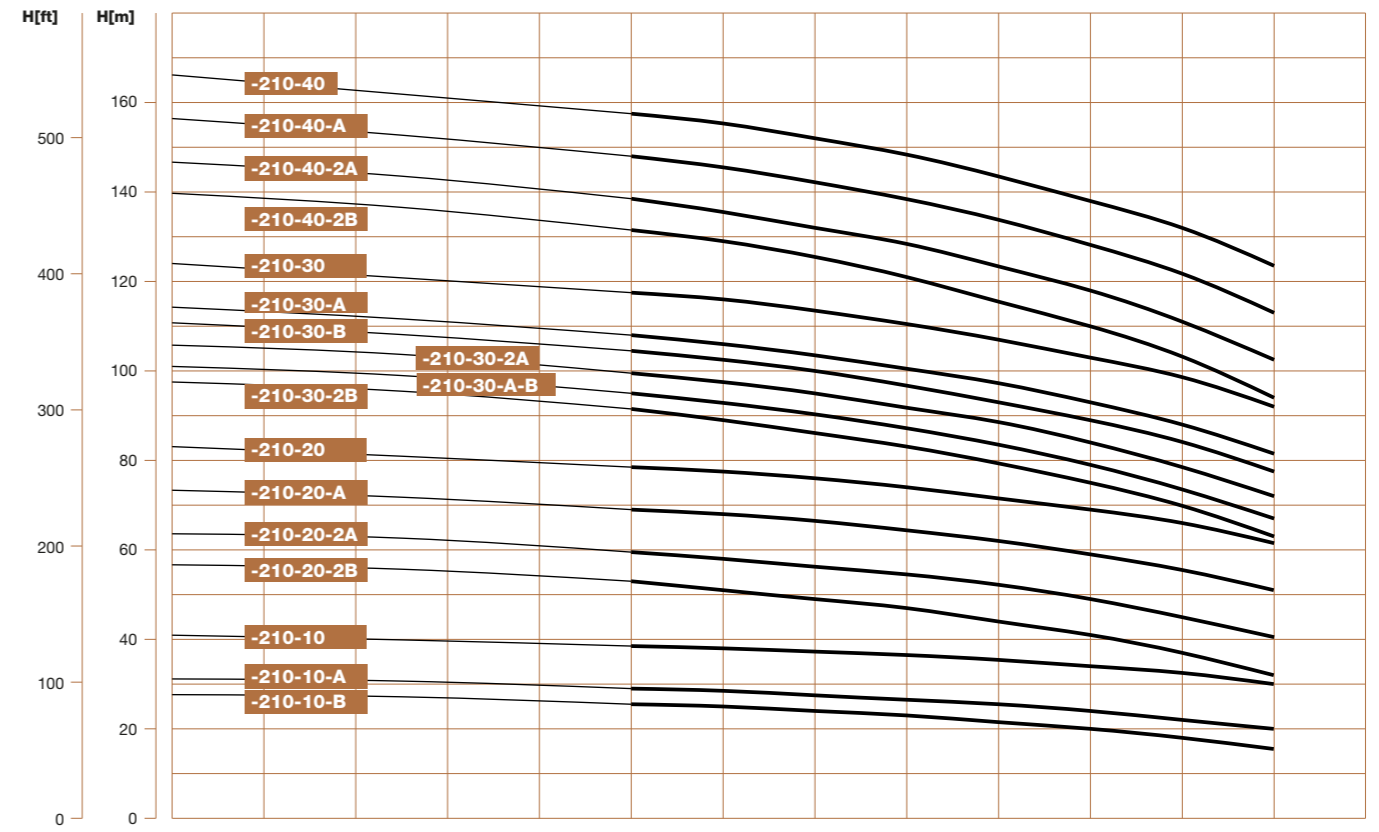
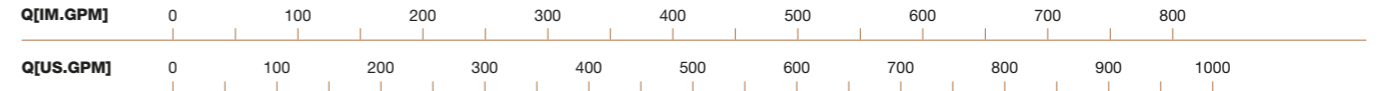



202203-CTL-VDROO-EN
subject to amendments

BE PUMPING PARTNERS

HYDROO **Pump Industries SL**

Carrer La Banyeta Nova, 11
Poligon Industrial La Banyeta
17843 Palol de Revardit
Catalonia. Spain

Tel. +34 972 394 654
E-mail: info@hydroo.com

www.hydroo.com

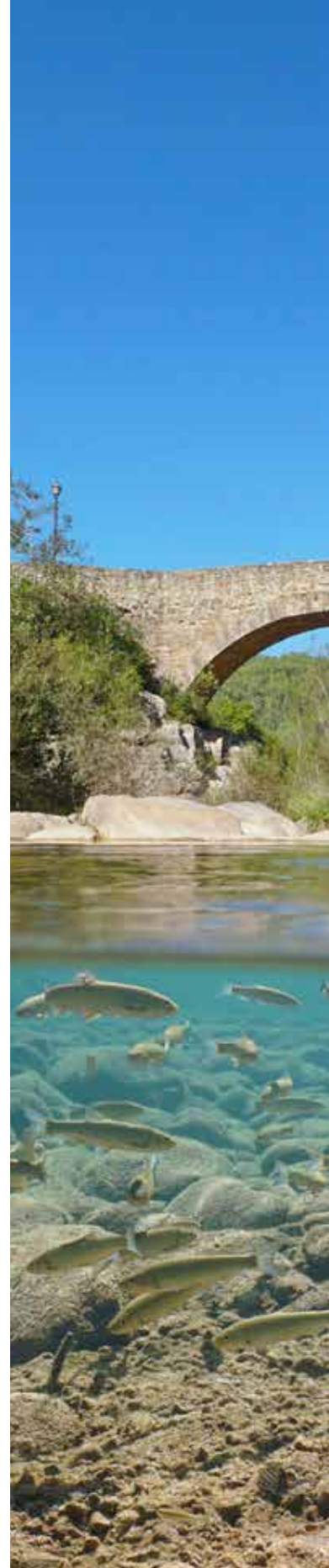

hydroo[®]