

HT PRO

Vertical multistage electric pumps



MADE IN ITALY

 **PEDROLLO**[®]
the spring of life

HT-PRO

Vertical multistage electric pumps

STAINLESS STEEL



- ※ **Made entirely of stainless steel:** Pump body, seal holder cover, impellers and diffusers made of AISI 304 stainless steel.
- ※ **Robust, compact and efficient:** HT-PRO multistage electric pumps have been designed with the aid of special structured fluid-dynamic calculation software in order to guarantee high levels of hydraulic performance combined with a simple, robust, compact and reliable mechanical construction.
- ※ **Superior reliability and minimal operating costs**
- ※ **Hydraulics with efficiency indexes MEI ≥ 0.4**
- ※ **Motor shaft:** AISI 316 stainless steel
- ※ **Mechanical seal:** Standard version with ceramic – graphite and NBR elastomer sliding faces. Available with sliding faces made of silicon carbide and EPDM and VITON elastomers.
- ※ **O-rings:** NBR standard version. EPDM and VITON available.



PERFORMANCE RANGE

- Flow rate up to **800 l/min** (48 m³/h)
- Head up to **160 m**

APPLICATION LIMITS

- Manometric suction lift up to **7 m**
- Liquid temperature between **-15°C** and **+90°C**
- Ambient temperature up to **+40°C**
- Max. working pressure **16 bar**
- Continuous service **S1**

INSTALLATION AND USE

Suitable for a water supply, for transferring clean liquids, and for pressurizing civic, industrial and agricultural plants. The multi-stage construction ensures very low operating noise thresholds. The newly designed electric motor, made to work with inverters, features bal-

anced and quiet operation. Efficiency class **IE3**, insulation class F and protection **IPX4**. The **CERAMIC – GRAPHITE – NBR** mechanical seal allows reliable and smooth operation over a long period of time.

OPTIONS AVAILABLE ON REQUEST

- Other voltages or 60 Hz frequency
- Pump made of AISI 316 stainless steel
- For liquids with higher or lower temperatures (MAX 110°C)
- Pump body with NPT ANSI B 1.20.1 threaded ports
- Kit for dry running protection

WARRANTY

2 years as per our general terms and conditions of sale

PERFORMANCE RANGE

50 Hz n= 2900 min⁻¹ HS= 0 m

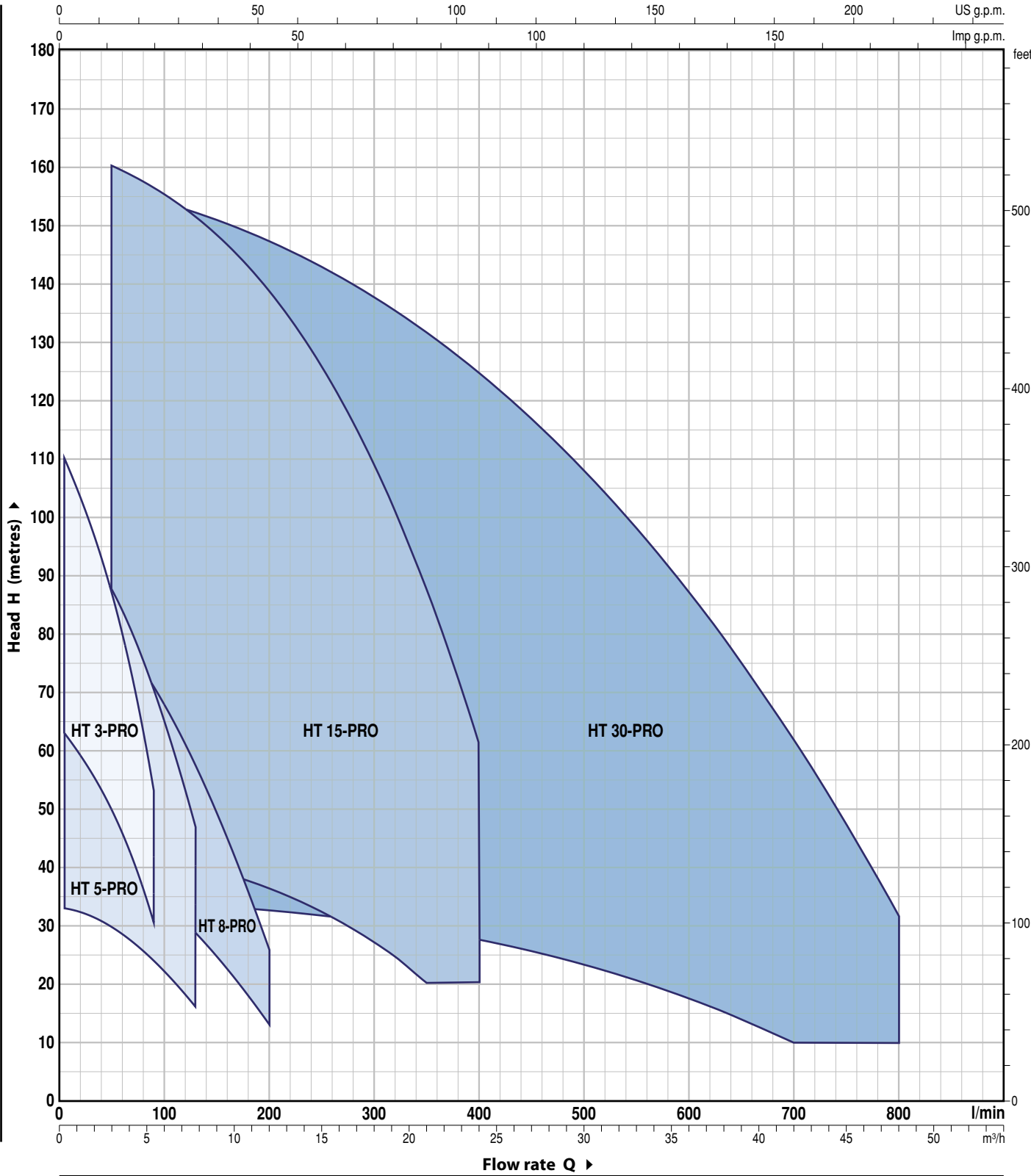

HT 3 - PRO

CHARACTERISTIC CURVES AND PERFORMANCE DATA

50 Hz n = 2900 min⁻¹ HS = 0 m

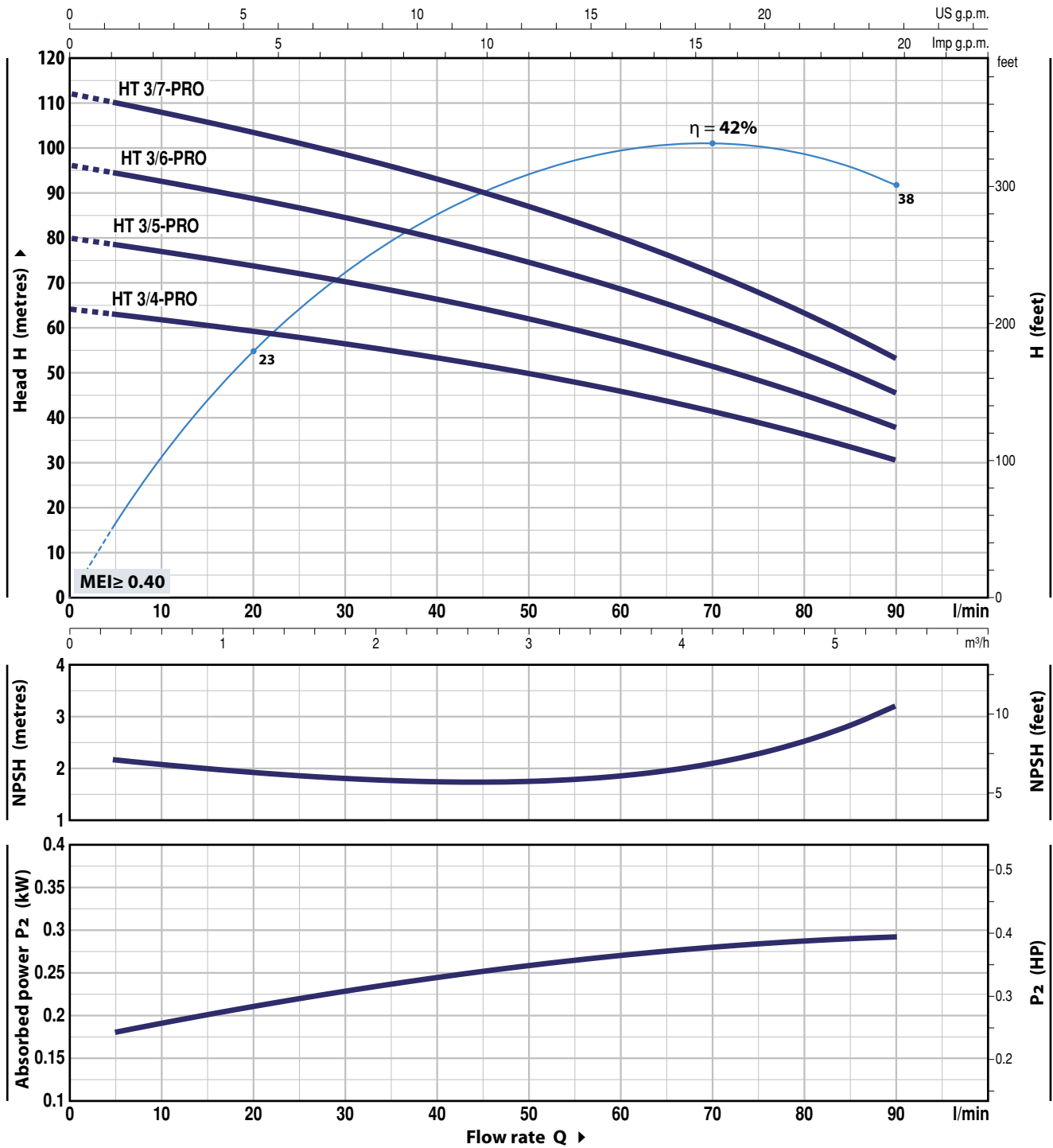

MODEL		POWER (P ₂)		▲	Q	Flow rate (l/min)							
Single phase	Three phase	kW	HP			0	5	10	20	40	60	80	90
HTm 3/4 - PRO	HT 3/4 - PRO	0.75	1	IE3	H metres	0	0.3	0.6	1.2	2.4	3.6	4.8	5.4
HTm 3/5 - PRO	HT 3/5 - PRO	1.1	1.5			64	63	61.5	59	53	45.5	36	30.5
HTm 3/6 - PRO	HT 3/6 - PRO	1.5	2			80	79	77	74	66.5	57	45	38
HTm 3/7 - PRO	HT 3/7 - PRO	1.8	2.5			96	94	92	89	80	68.5	54	45.5
						112	110	108	103	93	80	63	53

Q = Flow rate H = Total manometric head HS = Suction height

Tolerance of characteristic curves in compliance with EN ISO 9906 Grade 3B

▲ Three-phase motor efficiency class (IEC 60034-30-1)

HT 5 - PRO



CHARACTERISTIC CURVES AND PERFORMANCE DATA

50 Hz n= 2900 min⁻¹ HS= 0 m

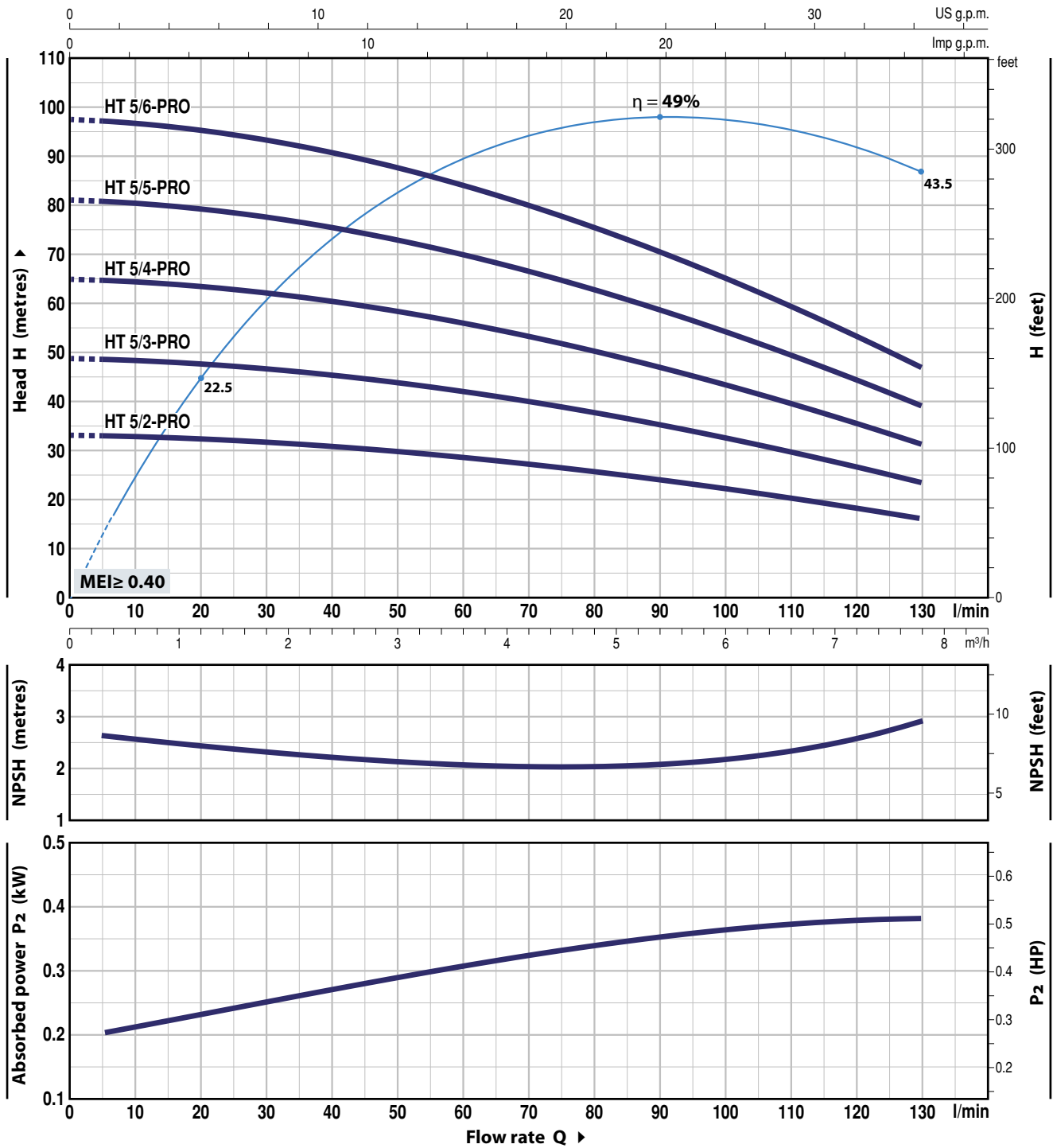

MODEL		POWER (P ₂)		▲	Q	Flow rate												
Single phase	Three phase	kW	HP			m³/h	0	0.3	0.6	1.2	2.4	3.6	4.8	5.4	6	7.8		
					l/min	0	5	10	20	40	60	80	90	100	130			
HTm 5/2 - PRO	HT 5/2 - PRO	0.75	1	IE3	H metres	33	33	32.7	32.3	30.5	28.5	25.5	24	22.2	16			
HTm 5/3 - PRO	HT 5/3 - PRO	1.1	1.5			49	49	48.5	47.5	45.5	42	37.5	35	32.5	24			
HTm 5/4 - PRO	HT 5/4 - PRO	1.5	2			65	65	64.5	63.5	60.5	56	50.5	47	43.5	32			
HTm 5/5 - PRO	HT 5/5 - PRO	1.8	2.5			81	81	80.5	79	76	70	63	58.5	54	39			
HTm 5/6 - PRO	HT 5/6 - PRO	2.2	3			98	97	97	95	91	84	75	70	65	47			

Q = Flow rate H = Total manometric head HS = Suction height

Tolerance of characteristic curves in compliance with EN ISO 9906 Grade 3B

▲ Three-phase motor efficiency class (IEC 60034-30-1)

HT 8 - PRO

CHARACTERISTIC CURVES AND PERFORMANCE DATA

50 Hz n= 2900 min⁻¹ HS= 0 m

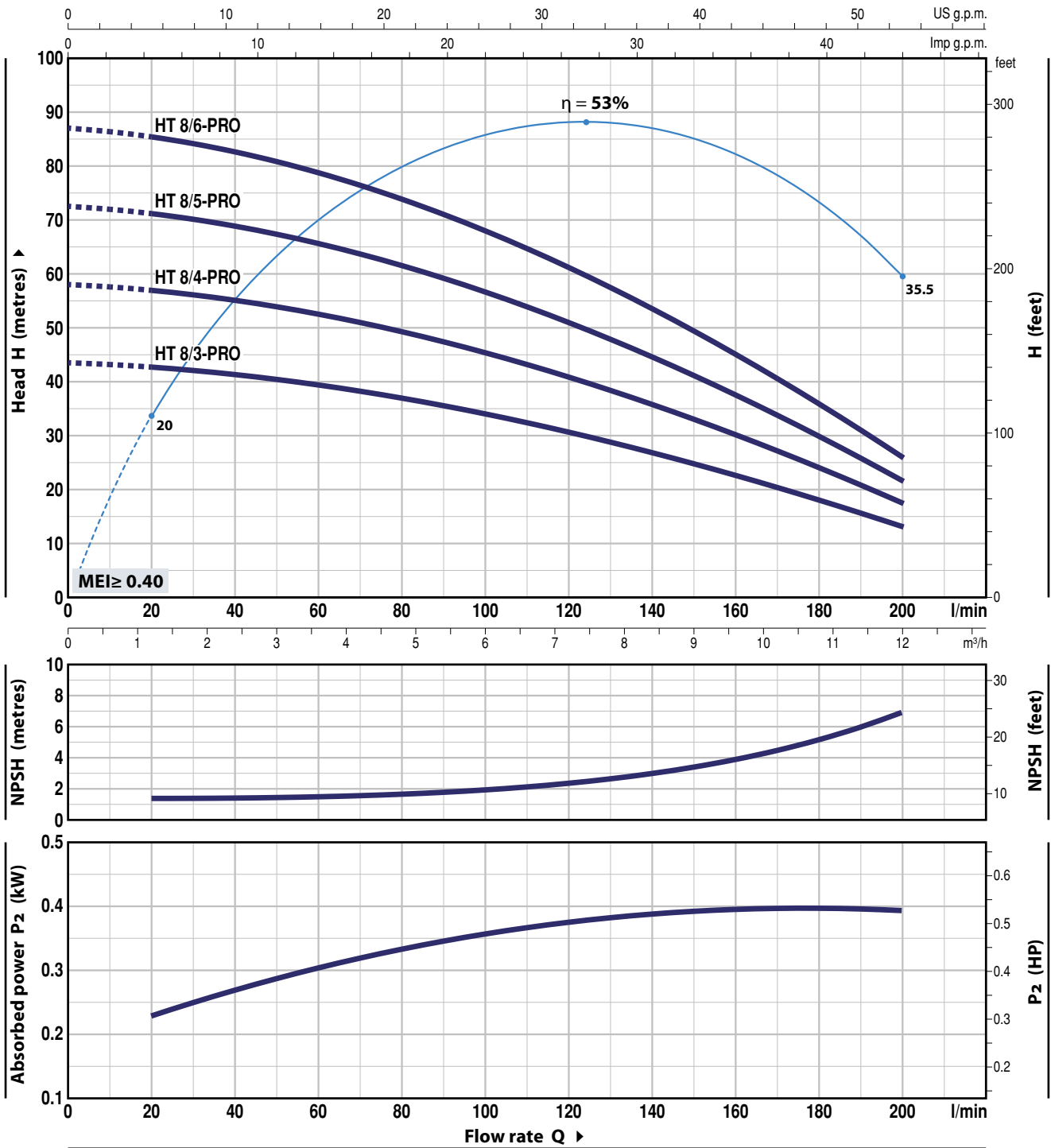

MODEL		POWER (P ₂)		▲	Q	Flow rate											
Single phase	Three phase	kW	HP			m ³ /h	0	1.2	2.4	3.6	4.8	6.0	7.2	8.4	9.6	10.8	12.0
					l/min	0	20	40	60	80	100	120	140	160	180	200	
HTm 8/3 - PRO	HT 8/3 - PRO	1.1	1.5	IE3	H metres	44	43	41.5	39.5	37	34	30.5	26.8	22.6	17.9	13	
HTm 8/4 - PRO	HT 8/4 - PRO	1.5	2			58	58	55	52.5	49.5	45.5	41	35.5	30	23.9	18	
HTm 8/5 - PRO	HT 8/5 - PRO	1.8	2.5			73	71.5	69	66	61.5	57	51	44.5	37.5	30	21.5	
HTm 8/6 - PRO	HT 8/6 - PRO	2.2	3			87	85.5	83	79	74	68	61.5	53.5	45	36	26	

Q = Flow rate H = Total manometric head HS = Suction height

Tolerance of characteristic curves in compliance with EN ISO 9906 Grade 3B

▲ Three-phase motor efficiency class (IEC 60034-30-1)

HT 15 - PRO



CHARACTERISTIC CURVES AND PERFORMANCE DATA

50 Hz n = 2900 min⁻¹ HS = 0 m

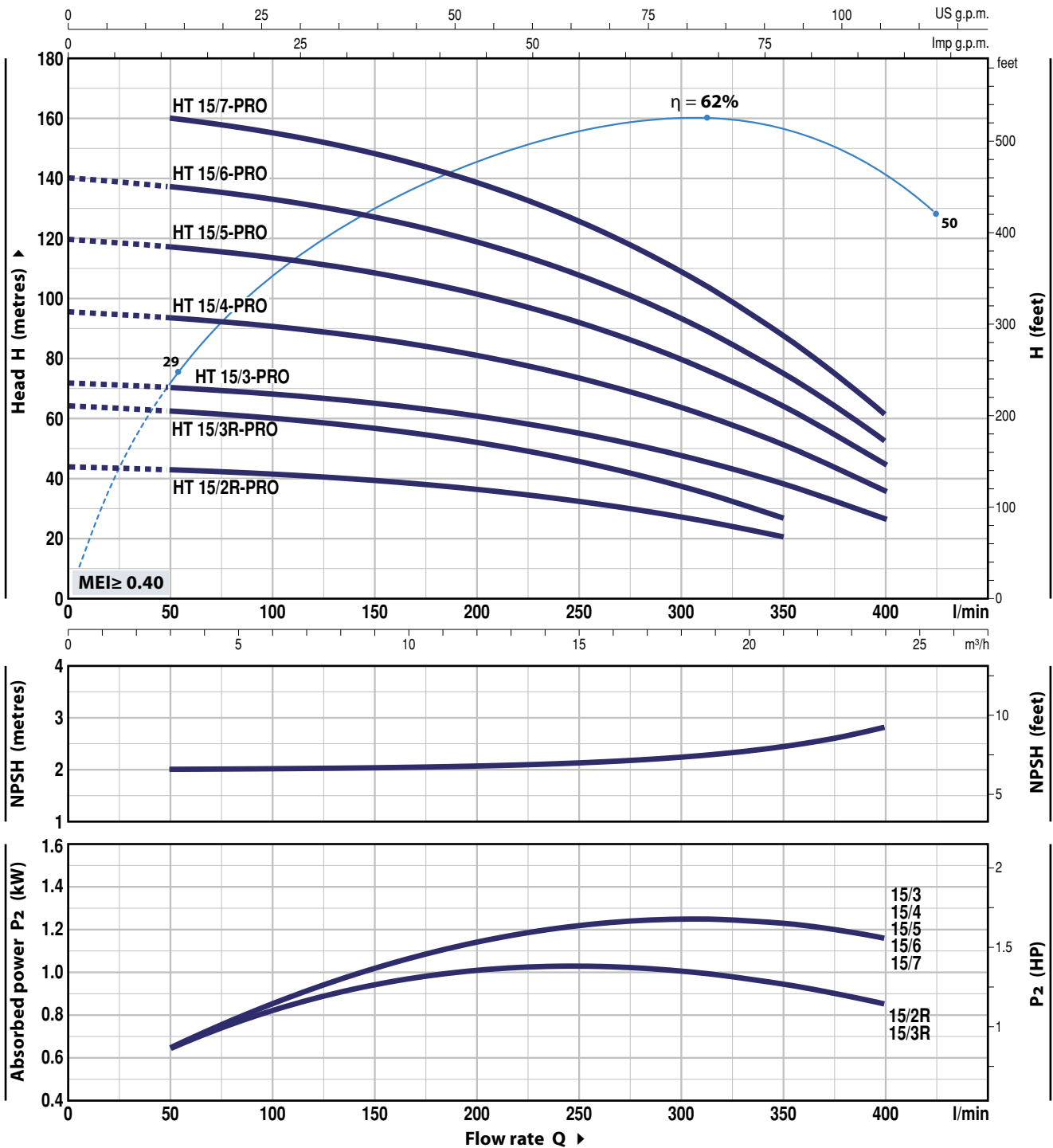

MODEL	POWER (P ₂)		▲	Q	Flow rate							
	kW	HP			0	3	6	12	18	21	24	
Three phase					0	50	100	200	300	350	400	
HT 15/2R - PRO	2.2	3	IE3	H metres	44	43	41.5	36.5	27.5	20.5	-	
HT 15/3R - PRO	3	4			64.5	62.5	60.5	52.0	37.5	27	-	
HT 15/3 - PRO	4	5.5			72	70	68.5	61	48	38.5	27	
HT 15/4 - PRO	5.5	7.5			96	94	91	81	64	51.5	36	
HT 15/5 - PRO	7.5	10			120	117	114	102	80	64.5	45	
HT 15/6 - PRO	9.2	12.5			140	137	133	119	94	75.5	52.5	
HT 15/7 - PRO	9.2	12.5			-	160	155	139	109	88	61.5	

Q = Flow rate H = Total manometric head HS = Suction height

Tolerance of characteristic curves in compliance with EN ISO 9906 Grade 3B

▲ Three-phase motor efficiency class (IEC 60034-30-1)

HT 30 - PRO

CHARACTERISTIC CURVES AND PERFORMANCE DATA

50 Hz n= 2900 min⁻¹ HS= 0 m

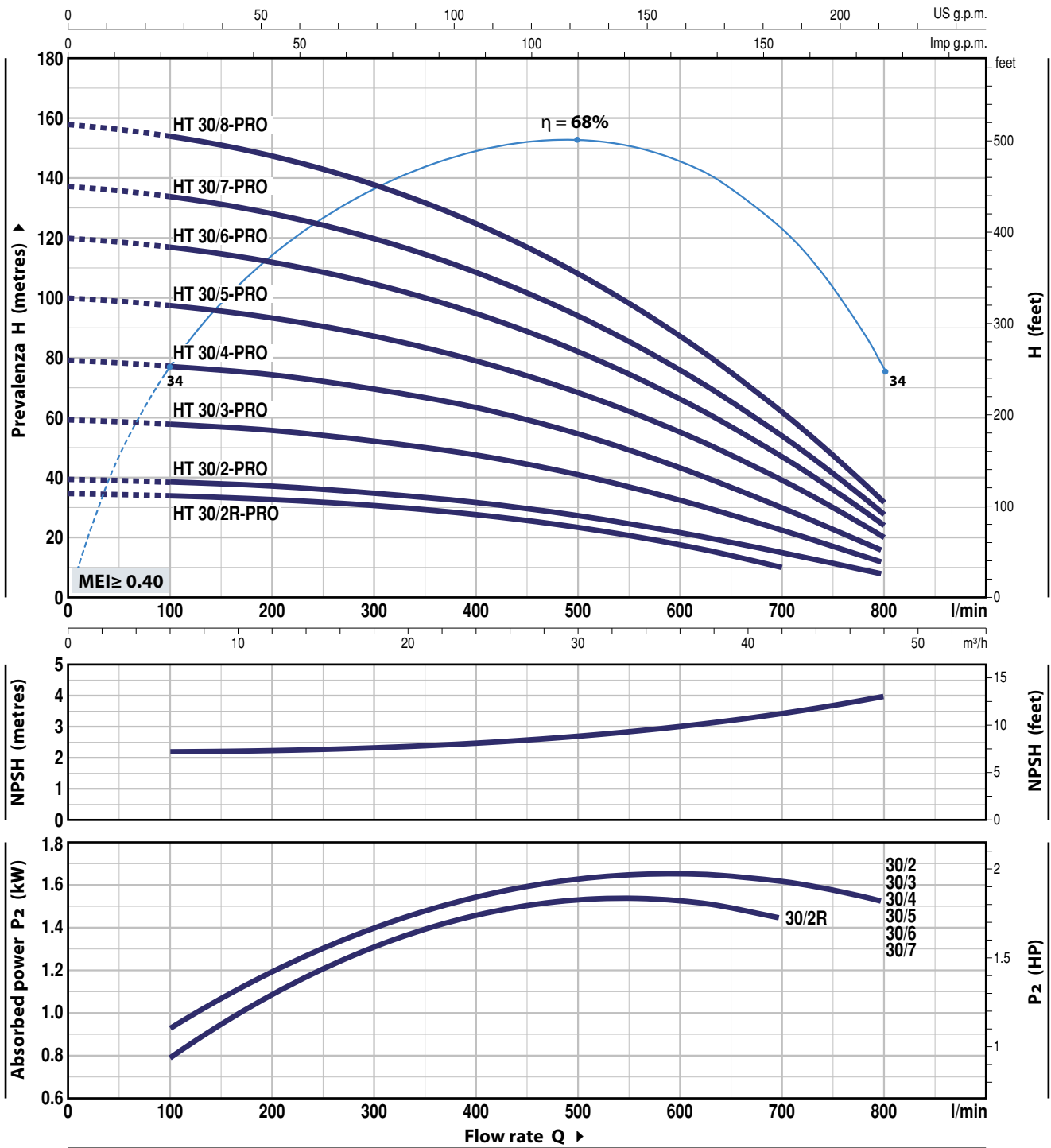

MODEL	POWER (P2)		▲	Q	Flow rate											
	kW	HP			0	6	12	18	24	36	42	48				
Three phase				l/min	0	100	200	300	400	600	700	800				
HT 30/2R - PRO	3	4	IE3	H metres	35	34	33	31	28	17.6	10	-				
HT 30/2 - PRO	4	5.5			40	39	37.5	35	31.5	22	15.7	8				
HT 30/3 - PRO	5.5	7.5			60	58.5	56	52.5	47.5	33	23.5	12				
HT 30/4 - PRO	7.5	10			80	78	75	70	63	44	31.3	16				
HT 30/5 - PRO	9.2	12.5			100	98	93	87	79	55	39	20				
HT 30/6 - PRO	11	15			120	117	112	105	95	66.5	47	24				
HT 30/7 - PRO	15	20			137	134	128	120	108	76	53.5	27.5				
HT 30/8 - PRO	15	20			158	154	147	138	125	87	62	31.5				

Q = Flow rate H = Total manometric head HS = Suction height

Tolerance of characteristic curves in compliance with EN ISO 9906 Grade 3B

▲ Three-phase motor efficiency class (IEC 60034-30-1)

POS. COMPONENT CONSTRUCTION CHARACTERISTICS

1	PUMP BODY	AISI 304 stainless steel with threaded ports in compliance with ISO 228/1
2	SEAL HOLDER COVER	AISI 304 stainless steel
3	LINER	AISI 304 stainless steel
4	IMPELLERS	AISI 304 stainless steel
5	DIFFUSERS	AISI 304 stainless steel
6	PUMP SHAFT	AISI 316L stainless steel

7 MECHANICAL SEAL

<i>Electric pump Model</i>	<i>Seal Model</i>	<i>Shaft Diameter</i>	<i>Materials</i>			
			<i>Stationary ring</i>	<i>Rotational ring</i>	<i>Elastomer</i>	<i>Spring</i>
HT 3 - PRO HT 5 - PRO HT 8 - PRO	FN-18	Ø 18 mm	Graphite	Ceramic	NBR	AISI 304
HT 15 - PRO HT 30 - PRO	FN-KU-24 ISO 3069 EN 12756	Ø 24 mm	Graphite	Ceramic	NBR	AISI 304

– BEARINGS

<i>Electric pump Model</i>	<i>Model</i>
HT 3 - PRO HT 5 - PRO HT 8 - PRO	6304 2RS-C3 / 6204 ZZ-C3E
HT 15 - PRO / HT 30 - PRO	up to 7.5 kW - 6307 ZZ - C3 / 6206 ZZ-C3
HT 15 - PRO / HT 30 - PRO	from 9.2 kW - 3309 A - 2RS1 / 6308 ZZ-C3

8 ELECTRIC MOTOR

- **HTm - PRO:** Single phase
230 V - 50 Hz
with condenser and thermal overload protector incorporated into the winding
- **HT - PRO:** Three phase
230/400 V - 50 Hz up to 4 kW
400/690 V - 50 Hz from 5.5 to 15 kW
- ➡ **The three phase pumps are fitted with high performance motors in class IE3 (IEC 60034-30-1)**
- Insulation: class F
- Protection: IP X4



HT - PRO

DIMENSIONS AND WEIGHT

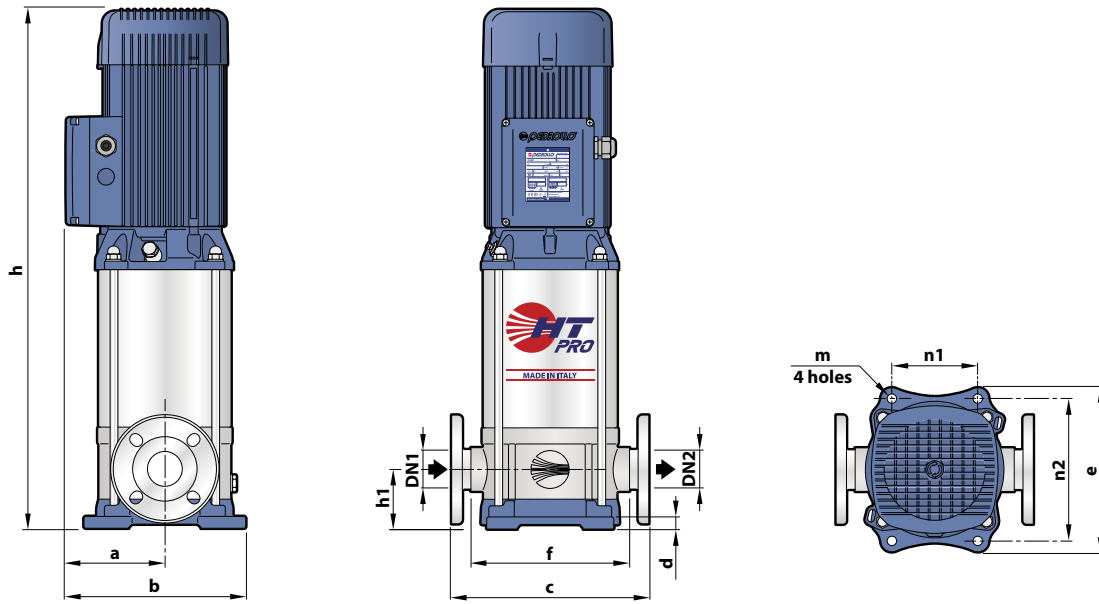

MODEL		PORTS		DIMENSIONS mm											kg		
Single phase	Three phase	DN1	DN2	a	b	c	d	e	f	h	h1	n1	n2	m	1~	3~	
HTm 3/4 - PRO	HT 3/4 - PRO	1"	1"							509							
HTm 3/5 - PRO	HT 3/5 - PRO									535							
HTm 3/6 - PRO	HT 3/6 - PRO									561							
HTm 3/7 - PRO	HT 3/7 - PRO									607							
HTm 5/2 - PRO	HT 5/2 - PRO	1 1/4"	1 1/4"	126	231	250	15	210	212	457	75	100	180	Ø 13			
HTm 5/3 - PRO	HT 5/3 - PRO									483							
HTm 5/4 - PRO	HT 5/4 - PRO									509							
HTm 5/5 - PRO	HT 5/5 - PRO									555							
HTm 5/6 - PRO	HT 5/6 - PRO	1 1/2"	1 1/2"			280			240	581	80						
HTm 8/3 - PRO	HT 8/3 - PRO									488							
HTm 8/4 - PRO	HT 8/4 - PRO									514							
HTm 8/5 - PRO	HT 8/5 - PRO									560							
HTm 8/6 - PRO	HT 8/6 - PRO	2"	2"	151	275	300		18	247	586	90						
-	HT 15/2R - PRO									589							
-	HT 15/3R - PRO									633							
-	HT 15/3 - PRO									677							
-	HT 15/4 - PRO	181	305						260	771							
-	HT 15/5 - PRO									900							
-	HT 15/6 - PRO									944							
-	HT 15/7 - PRO									990							
-	HT 30/2R - PRO	2 1/2"	2 1/2"	151	275	320		18	247	604	105	130	215	Ø 14			
-	HT 30/2 - PRO									648							
-	HT 30/3 - PRO									742							
-	HT 30/4 - PRO									871							
-	HT 30/5 - PRO	181	305						274	915							
-	HT 30/6 - PRO									959							
-	HT 30/7 - PRO									1003							
-	HT 30/8 - PRO									1003							

FLANGES

MODEL	DN FLANGES mm	D mm	K mm	HOLES	
				N°	Ø mm
HT 3 - PRO	25	115	85	4	14
HT 5 - PRO	32	140	100		
HT 8 - PRO	40	150	110		
HT 15 - PRO	50	165	125		
HT 30 - PRO	65	185	145		

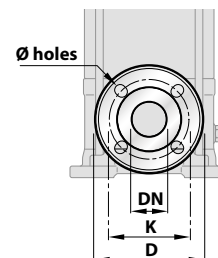

CURRENT DRAW

MODEL	VOLTAGE	
	230 V	240 V
Single phase		
HTm 3/4 - PRO	7.5 A	7.2 A
HTm 3/5 - PRO	9.0 A	8.6 A
HTm 3/6 - PRO	10.5 A	10.1 A
HTm 3/7 - PRO	12.5 A	12.0 A
HTm 5/2 - PRO	6.5 A	6.2 A
HTm 5/3 - PRO	8.5 A	8.1 A
HTm 5/4 - PRO	10.3 A	9.9 A
HTm 5/5 - PRO	12.5 A	12.0 A
HTm 5/6 - PRO	13.5 A	13.0 A
HTm 8/3 - PRO	8.7 A	8.3 A
HTm 8/4 - PRO	10.5 A	10.1 A
HTm 8/5 - PRO	12.5 A	12.0 A
HTm 8/6 - PRO	14.0 A	13.5 A

MODEL	VOLTAGE					
	230 V	400 V	690 V	240 V	415 V	720 V
Three phase						
HT 3/4 - PRO	5.2 A	3.0 A	1.7 A	5.0 A	2.9 A	1.7 A
HT 3/5 - PRO	6.1 A	3.5 A	2.0 A	5.9 A	3.4 A	1.9 A
HT 3/6 - PRO	6.9 A	4.0 A	2.3 A	6.6 A	3.8 A	2.2 A
HT 3/7 - PRO	8.3 A	4.8 A	2.8 A	8.0 A	4.6 A	2.7 A
HT 5/2 - PRO	4.9 A	2.8 A	1.6 A	4.7 A	2.7 A	1.6 A
HT 5/3 - PRO	5.6 A	3.2 A	1.8 A	5.4 A	3.1 A	1.8 A
HT 5/4 - PRO	6.9 A	4.0 A	2.3 A	6.6 A	3.8 A	2.2 A
HT 5/5 - PRO	8.7 A	5.0 A	2.9 A	8.3 A	4.8 A	2.8 A
HT 5/6 - PRO	9.0 A	5.2 A	3.0 A	8.6 A	5.0 A	2.9 A
HT 8/3 - PRO	5.9 A	3.4 A	2.0 A	5.7 A	3.3 A	1.9 A
HT 8/4 - PRO	7.3 A	4.2 A	2.4 A	6.9 A	4.0 A	2.3 A
HT 8/5 - PRO	8.7 A	5.0 A	2.9 A	8.3 A	4.8 A	2.8 A
HT 8/6 - PRO	9.5 A	5.5 A	3.2 A	9.2 A	5.3 A	3.0 A
HT 15/2R - PRO	10.4 A	6.0 A	3.5 A	10.0 A	5.8 A	3.3 A
HT 15/3R - PRO	11.8 A	6.8 A	3.9 A	11.3 A	6.6 A	3.8 A
HT 15/3 - PRO	15.2 A	8.8 A	5.1 A	14.6 A	8.4 A	4.9 A
HT 15/4 - PRO	19.4 A	11.2 A	6.5 A	18.6 A	10.7 A	6.2 A
HT 15/5 - PRO	24.4 A	14.1 A	8.2 A	23.4 A	13.5 A	7.8 A
HT 15/6 - PRO	26.0 A	15.0 A	8.7 A	24.9 A	14.4 A	8.3 A
HT 15/7 - PRO	28.5 A	16.5 A	9.5 A	27.3 A	15.8 A	9.1 A
HT 30/2R - PRO	12.2 A	7.0 A	4.1 A	11.7 A	6.7 A	3.9 A
HT 30/2 - PRO	15.2 A	8.8 A	5.1 A	14.6 A	8.4 A	4.9 A
HT 30/3 - PRO	19.4 A	11.2 A	6.5 A	18.6 A	10.7 A	6.2 A
HT 30/4 - PRO	24.4 A	14.1 A	8.2 A	23.4 A	13.5 A	7.8 A
HT 30/5 - PRO	28.5 A	16.5 A	9.5 A	27.3 A	15.8 A	9.1 A
HT 30/6 - PRO	32.0 A	18.5 A	10.7 A	30.7 A	17.7 A	10.3 A
HT 30/7 - PRO	37.2 A	21.5 A	12.4 A	35.7 A	20.6 A	11.9 A
HT 30/8 - PRO	41.5 A	24.0 A	13.9 A	39.8 A	23.0 A	13.3 A

CAPACITOR

MODEL	CAPACITY
Single phase	(230 V or 240 V)
HTm 3/4 - PRO	31.5 μ F 450 VL
HTm 3/5 - PRO	
HTm 5/2 - PRO	
HTm 5/3 - PRO	
HTm 8/3 - PRO	45 μ F 450 VL
HTm 3/6 - PRO	
HTm 5/4 - PRO	
HTm 8/4 - PRO	50 μ F 450 VL
HTm 3/7 - PRO	
HTm 5/5 - PRO	
HTm 5/6 - PRO	
HTm 8/5 - PRO	
HTm 8/6 - PRO	

*The data contained in this publication are not to be considered binding.
Pedrollo S.p.A. reserves the right to make any changes it deems appropriate to improve its production.*

Via Enrico Fermi, 7 - 37047 San Bonifacio (Verona) Italy
tel. +39 045 6136311 - fax +39 045 7614663
vendite@pedrollo.com - sales@pedrollo.com - www.pedrollo.com

MADE IN ITALY

Z-DPL90083UK_05